

1973

Analysis of open steel box sections with bracing, M.S. thesis, October 1973.

Robert S. McDonald

Follow this and additional works at: <http://preserve.lehigh.edu/engr-civil-environmental-fritz-lab-reports>

Recommended Citation

McDonald, Robert S., "Analysis of open steel box sections with bracing, M.S. thesis, October 1973." (1973). *Fritz Laboratory Reports*. Paper 2050.
<http://preserve.lehigh.edu/engr-civil-environmental-fritz-lab-reports/2050>

This Technical Report is brought to you for free and open access by the Civil and Environmental Engineering at Lehigh Preserve. It has been accepted for inclusion in Fritz Laboratory Reports by an authorized administrator of Lehigh Preserve. For more information, please contact preserve@lehigh.edu.

21

ANALYSIS OF OPEN STEEL BOX SECTIONS WITH BRACING

by

Robert E. McDonald

A THESIS

Presented to the Graduate Committee
of Lehigh University
in Candidacy for the Degree of
Master of Science
in
Department of Civil Engineering

Lehigh University

October 1973

380.7 T

CERTIFICATE OF APPROVAL

This thesis is accepted and approved in partial fulfillment of the requirements for the degree of Master of Science in Civil Engineering.

September 10, 1973
(Date)

Professor B. T. ~~Xen~~
Professor in Charge

Professor D. A. VanHorn
Chairman,
Department of Civil Engineering

ACKNOWLEDGMENTS

The work upon which this thesis is based is a part of the research project "Strength of Rectangular Composite Box Girders". The project is sponsored by the Pennsylvania Department of Transportation with the Federal Highway Administration, and is being conducted at Fritz Engineering Laboratory and the Department of Civil Engineering, Lehigh University. The laboratory is directed by Dr. Lynn S. Beedle and the Chairman of the Department is Dr. David A. VanHorn.

The author is especially appreciative of Dr. Ben T. Yen, Director of the research project, for his helpful suggestions and pertinent guidance. Special thanks are due Messrs. Yeou-Chen and Cetin Yilmaz for their help in all phases of this thesis.

Appreciation is extended to Mrs. Dorothy Fielding for typing the manuscript.

TABLE OF CONTENTS

	<u>Page</u>
ABSTRACT	1
1. INTRODUCTION	2
2. TESTS OF MODEL SPECIMENS	3
2.1 Description of Specimens	3
2.2 Testing Procedure and Instrumentation	4
2.3 Overall Behavior	4
3. STRESS ANALYSIS	6
3.1 Equivalent Thickness Concept	6
3.2 Stress Analysis of Equivalent Closed Section	7
3.3 Stress Analysis of Bracing	9
4. COMPARISON OF EXPERIMENTAL AND ANALYTICAL RESULTS	12
4.1 Normal Stresses in Webs and Flanges of Braced Open Sections	12
4.2 Shearing Stresses in the Braced Open Section	13
4.3 Rotation of the Braced Open Section	14
4.4 Stresses in Top Bracing	15
5. DISCUSSION AND RECOMMENDATIONS	17
FIGURES	20
REFERENCES	40
VITA	41

LIST OF FIGURES

<u>Figure</u>		<u>Page</u>
1	GEOMETRY OF BRACED SPECIMEN - D1	20
2	GEOMETRY OF BRACED SPECIMEN - D2	21
3	MIDSPAN DEFLECTION UNDER LOAD	22
4	DEFLECTION AT OVERHANG, UNDER LOAD	23
5	TOP BRACING ARRANGEMENTS	24
6	STRESSES ON EQUIVALENT TOP PLATE AND LOADING CONDITIONS FOR TOP BRACING FRAME	25
7	NORMAL TENSILE STRESSES IN OPEN BOX SECTION - LOAD AT MIDSPAN	26
8	NORMAL COMPRESSIVE STRESSES IN OPEN BOX SECTION- LOAD AT MIDSPAN	27
9	NORMAL TENSILE STRESSES IN OPEN BOX SECTION - LOAD AT OVERHANG	28
10	NORMAL COMPRESSIVE STRESSES IN OPEN BOX SECTION - LOAD AT OVERHANG	29
11	SHEAR STRESSES AT CENTERLINE OF BOTTOM FLANGE - LOAD AT MIDSPAN	30
12	SHEAR STRESSES AT CENTERLINE OF BOTTOM FLANGE - LOAD AT OVERHANG	31
13	WEB SHEAR STRESSES - LOAD AT MIDSPAN	32

LIST OF FIGURES (continued)

<u>Figure</u>		<u>Page</u>
14	WEB SHEAR STRESSES - LOAD AT OVERHANG	33
15	MIDSPAN ROTATION	34
16	ROTATION AT OVERHANG	35
17	TENSILE STRESSES IN TOP BRACING - LOAD AT MIDSPAN	36
18	COMPRESSIVE STRESSES IN TOP BRACING - LOAD AT MIDSPAN	37
19	NORMAL STRESSES IN TOP BRACING - LOAD AT OVERHANG	38
20	K_T versus t_e - SPECIMEN D1	39

ABSTRACT

Braced open thin-walled steel box girders under combined bending and torsion were studied. Two model box girders were tested in the elastic range. Analytically, the top bracing of open box sections was converted to an equivalent plate thus forming an equivalent closed box. Experimental results on braced open box and theoretically computed stresses for the equivalent closed box agreed well. The computed rotations underestimate slightly the experimental values. Deformation of cross section was neglected in the analysis.

The stresses in the bracing members were estimated using stresses in the equivalent top plate as loads on a bracing frame. The estimated stresses also compared well with experimental results.

Based on the concept of equivalent closed box and the top flange bracing frame, a procedure was recommended for the selection of bracing member sizes.

1. INTRODUCTION

The use of thin-walled steel box girders as bridge members has increased in the past decade due to economic considerations, aesthetic desirability, and the torsional rigidity of a box section. For steel-concrete composite box girders, the steel cross section alone is usually erected first with the concrete deck added after the steel section is in place. The steel section is an "open" section composed of the bottom flange, two vertical or inclined webs, and some transverse and longitudinal stiffeners. To help distribute loads and to increase the torsional rigidity of the open section during erection and subsequent stages of construction, bracing is commonly placed at the top flange level between the two webs.

Little has been reported in the literature on the open cross section of box girders in the phases of construction. The purpose of this study is threefold: 1) to investigate the behavior of a braced open box section under loads eccentric to its longitudinal centerline; 2) to evaluate the stresses in the bracing members; and 3) to develop a method of estimating the strength requirement for the top bracing of an open steel box girder section during construction.

2. TESTS OF MODEL SPECIMENS

2.1 Description of Specimens

Two model box girders were studied. The specimens were designated D1 and D2⁽¹⁾, and are shown in Figs. 1 and 2. The open cross section of the models were rectangular in shape, 15 in. wide and 12 in. high, and had a 10 ft. simple span with a 2 ft. cantilever section. The component plates were connected by intermittent fillet welds.

Specimen D1 was designed by the allowable stress approach according to the 1969 AASHO Standard Specifications⁽²⁾, whereas specimen D2 was designed using the load-factor design rules of the 1971 AASHO Interim Specifications⁽³⁾. The arrangement of longitudinal and transverse stiffeners thus was different, in addition to the difference in web plate thickness. Both specimens had plate diaphragms at the loading points and the support points as shown in Figs. 1 and 2. An intermediate diaphragm was added to specimen D2. The same general pattern of bracing was placed at the top flange level of both models.

The steel for the specimens had an average yield point $\sigma_y = 30$ ksi. Young's modulus and the shear modulus were taken as $E = 29,500$ ksi and $G = 11,300$ ksi.

2.2 Testing Procedure and Instrumentation

Two types of loading conditions were investigated: "positive" bending of simple span and negative bending of the cantilever, both under eccentric load with respect to the longitudinal centerline of the girders. Loads were applied non-concurrently by hydraulic jacks, at positions P_B and P_D as shown in Figs. 1 and 2.

Since the braced open section of a box girder is loaded primarily during construction phases and the stresses in the section are normally within the elastic range, loads on the model specimens were kept between 80 - 100% of the computed yield loads of the open cross sections. For the simple span loading, the magnitude was 6 kips applied at 2 kip increments; for the cantilevers; 9 kips at 3 kip intervals.

Horizontal and vertical deflections of the box girder cross section were measured with 0.001 in. Ames dial gages at the support and loading points as well as the quarter points. From the measured deflections, rotations were calculated.

Stresses at various points of the specimen were obtained using electrical resistance strain rosettes and linear strain gages at both faces of the web and the bottom flange of the plate. Only single, linear strain gages were used on the bracing members.

2.3 Overall Behavior

Overall, the testing of these models was "uneventful". No drastic change of behavior was observed and the specimens retained their original configuration after removal of the loads.

Under the applied loads, the specimens responded elastically as indicated by the linear load-deflection ($P - \Delta$) relationship in Figs. 3 and 4. The measured vertical deflections of the braced open cross sections were substantially less than those theoretically computed values for open cross sections without the top flange bracing members.

Similarly, the rotation of the braced open cross section were found to be less than those predicted for open cross sections without bracing. This reduction of deflection and rotation implied the higher rigidity of the braced sections against torsion as it was anticipated.

Other results of testing will be presented later in comparison with analytical results.

3. STRESS ANALYSIS

3.1 Equivalent Thickness Concept

Some analytical work has been done^(4,5) to convert the top bracing of an open box section to an equivalent top plate of thickness, t_e . This it is hypothesized that a braced open cross section has an equivalent closed box section. The equivalent thickness was obtained through consideration of strain energy and by calculating the bracing force required to prevent a relative deflection of the top of the webs.

For various patterns of bracing of open cross sections, depicted by Fig. 5, Basler and Kollbrunner⁽⁴⁾ developed expressions for the thickness of the equivalent top plate.

$$t_e = \frac{E}{G} \frac{ab}{\frac{d^3}{A_d} + \frac{2a^3}{3A_f}} \quad (1a)$$

$$t_e = \frac{E}{G} \frac{ab}{\frac{2d^3}{A_d} + \frac{b^3}{A_v} + \frac{a^3}{6A_f}} \quad (1b)$$

$$t_e = \frac{E}{G} \frac{ab}{\frac{d^3}{2A_d} + \frac{a^3}{6A_f}} \quad (1c)$$

$$t_e = \frac{E}{G} \frac{ab}{\frac{d^3}{A_d} + \frac{b^3}{A_v} + \frac{a^3}{6A_f}} \quad (1d)$$

$$t_e = \frac{E}{G} \frac{1}{\frac{ab^2}{12I_t} + \frac{a^2b}{24I_f}} \quad (1e)$$

where

t_e = thickness of equivalent top plate, in.

E = modulus of elasticity of steel, ksi

G = shear modulus of steel, ksi

a = spacing between transverse bracing members, in.

b = width of cross section at bracing level, in.

d = length of diagonal bracing member, in.

A_d = area of diagonal bracing member, in.²

A_f = area of real flange on top of a web, in.²

A_t = area of transverse bracing member which is assumed to perform like a beam member, in.⁴

I_t = moment of inertia of transverse bracing member which is assumed to perform like a beam member, in.⁴

I_f = moment of inertia of real flange on top of a web, in.⁴

Any combination of these patterns of bracing can be handled by adding t_e for each component pattern and arriving at a total thickness of an equivalent top flange.

3.2 Stress Analysis of Equivalent Closed Section

By transforming the bracing to an equivalent top plate, an effective closed box section is obtained. Analytical methods of stress analysis

for closed sections can then be applied. Stresses can be computed for any point on any cross section along the length of a box girder. There are a number of available methods for stress computation. These include the method of beam on elastic foundation (BEF)⁽⁶⁾, the folded plate theory⁽⁷⁾, the finite element procedure, and the thin-walled elastic beam theory⁽⁸⁾.

The thin-walled elastic beam theory assumes that the plates do not buckle, deflections are small, stresses are in the elastic range, and distortional stresses are negligible. From this theory, the governing differential equation for a member subjected to a concentrated torque is given by: (9)

$$\phi = G K_T \phi' - E I_\omega \phi''' \quad (2)$$

where

ϕ = the rotation of the cross section, rad.

ϕ' = the first derivative of $\phi = d\phi/dz$

ϕ''' = the third derivative of $\phi = d^3\phi/dz^3$

K_T = St. Venant torsional constant =

$$\frac{4A_o}{\frac{ds}{t(s)}} \text{ (for closed slope), in.}^4$$

I_ω = warping moment of inertia = $\int \omega_m^2 t(s) ds$, in.⁶

After solving this equation for ϕ , the values of its derivatives can also be obtained for any cross section along the length of the member. The stresses at a given point on the cross section can then be calculated as follows:

$$\sigma_T = \sigma_b + \sigma_w \quad (3a)$$

$$\tau_T = \tau_b + \tau_w + \tau_{sv} \quad (3b)$$

where

σ_T = total normal stress

σ_b = normal stress due to bending = $\frac{M}{I} c$

σ_w = normal stress due to warping = $E \omega_n \phi''$

τ_T = total shear stress

τ_b = shear stress due to bending = $\frac{UQ}{I_b}$

τ_w = shear stress due to warping = $-\frac{ES_w \phi'''}{t}$

τ_{sv} = shear stress due to pure torsion, also called St. Venant shear stress =

$$\frac{G K_T \phi'}{2 A_o t}$$

3.3 Stress Analysis of Bracing

The stresses in the top bracing member can be evaluated from the stresses in the equivalent top plate of the box section. Since the top plate is an imaginary one, the stresses therein are not real, and the computed stresses in the bracing members are only estimates of the actual stresses.

To convert these "pseudo" stresses in the equivalent top plate into stresses in the bracing members, each panel of the top bracing (Fig. 6) is analyzed as a plane rigid frame with the pseudo stresses

in the equivalent top plate acting as loads on this frame. The frame consists of the transverse and diagonal bracing members and the actual top flanges of the webs (Fig. 6c). The diagonal members are assumed pin-connected. The support conditions of the frame are idealized as a hinge and a roller as shown.

The stresses at points in the equivalent top plate of a cross section are given by Eqs. 3, and the distribution of stresses across the top plate are shown in Figs. 6a and 6b. There are three shear stress components: (1) bending shear (τ_b) due to the shearing force (v), St. Venant or torsional shear (τ_{sv}) due to the twisting moment (M_T), and warping shear (τ_w) due to the same twisting moment. The warping and St. Venant shear are uniformly distributed on the top plate while the flexural shear is linearly varying across the plate width. Similarly the normal stresses at the same cross section include the bending normal stress (σ_b) and the warping normal stresses (σ_w). The bending normal stresses are constant at a cross section and the warping normal stresses vary linearly across the plate. No shear lag effect is considered. Distorsional stresses due to the cross section not retaining its shape are neglected as it has been demonstrated⁽⁶⁾ to be negligible.

The shear stresses in the equivalent top plates are transformed into shear flow, $q = \tau t_e$. These shear flows are then applied to the bracing frame (Fig. 6d). Along the longitudinal top edge of the webs, the shear flows are either uniform or linearly distributed. The normal stresses are multiplied by the areas of the actual flanges to give normal forces acting on the frame (Fig. 6e).

The rigid frame with the applied forces is then analyzed by any method available, such as a direct stiffness method or flexibility method, to obtain forces and stresses in the actual diagonal bracing members.

In the analysis it was found that the bending and warping shear as well as the warping normal forces contributed little to the forces in the bracing members. Therefore, only bending normal forces and St. Venant shear flow are applied to the frame for the computation of forces in the bracing members.

4. COMPARISON OF EXPERIMENTAL AND ANALYTICAL RESULTS

4.1 Normal Stresses in Webs and Flange of Braced Open Section

Normal stresses in the braced open section of the two model girders were analytically determined using the equivalent closed section procedure described in Section 3.2. Figures 7, 8, 9 and 10 present both the experimental normal stresses and the analytical normal stresses at various points in the webs and flanges of specimens D1 and D2. The experimental data is plotted as open shapes connected by solid lines; the analytical results as broken lines. Both warping normal stresses and bending normal stresses were included in the analysis, while the stresses due to distortion of the cross section were found negligible for these specimens and were excluded.

A number of observations can be made from the results in Figs. 7, 8, 9 and 10. First, the measured and computed stresses agreed fairly well with the measured stresses slightly lower than those computed values. The maximum difference is in the order of 1 ksi. This is a relatively low value considering that the intermediate diaphragm and the stiffeners were neglected in the analysis, that the condition of simple supports was not met because of the tie-down system to prevent uplifting and that the transformation from a braced open section to an equivalent closed section is a gross approximation.

Qualitatively it appears that difference between measured and computed stresses were smaller in the web away from the load and comparatively larger in the web under the load. This could partially be due to the assumption of point loading whereas actual loads were spread over 6 in. and to the condition that the intermediate diaphragm of D2 was not considered in the theoretical computation.

4.2 Shearing Stresses in the Braced Open Section

The total shearing stress at a point was determined by adding that due to St. Venant torsion, warping torsion, and bending. As in the cases of normal stresses, the distortional stresses resulting from deformation of cross sections were not included in the analytical computation.

The shearing stresses at a few points in the webs and flanges of the specimens were recorded and are compared with computed values in Figs. 11, 12, 13 and 14. Again, the experimental results are presented by open shapes and the analytical values by broken lines. Overall, the agreement between computed and measured stresses is quite good, with a maximum difference of less than 1 ksi.

For the open box girder section, loads must necessarily be along the webs. The torsional moment then can not be too large, nor can its ratio to the bending moment be large. The torsional shearing stresses in the cross section therefore were not expected to be high. This is confirmed by both the computed and the experimental data for points on the bottom flange plate (Figs. 11 and 12). For the webs

(Figs. 13 and 14) torsional shearing stresses constituted only 20 to 30 percent of the total shear, the majority being contributed by flexural shear. This condition probably is the underlining factor for the overall good agreement between measured stresses and computed values using the analytical model.

4.3 Rotations of the Braced Open Section

The rotations of the braced open box girder specimens were calculated from measured deflection data. These rotation values are shown in Figs. 15 and 16 for a number of cross sections. Also shown are the analytically computed rotations of the equivalent closed box sections using Eq. 2. For comparison, computed rotations of sections without bracing are also included in the figures.

It is obvious from these figures that the "measured" rotations at maximum applied loads were substantially smaller than those computed without considering the top bracing members, signifying the effectiveness of the bracing. On the other hand, the measured values were moderately higher than those analytical results of the equivalent closed box section in the same order of magnitude. This indicates that the analytical model can be used qualitatively to estimate the magnitude of cross sectional rotation.

In comparing rotation of the two model box girders, it was anticipated that specimen D1 would be more rigid since it had a thicker web and more top bracing members (Figs. 1 and 2). The theoretical lines in Figs. 15 and 16 reflect this difference in

rigidity. In actual condition, the intermediate K-diaphragm of specimen D2, neglected in the analytical computation, possibly contributed to the result that smaller rotations were exhibited by specimen D2 than the expectedly more rigid specimen D1 (Fig. 15). For the overhanging portion of the specimens, no intermediate diaphragm existed and specimen D2 did rotate more than D1.

Figures 15 and 16 show that there was appearingly nonlinear rotational behavior of the specimens. One possible explanation is the effect of cross-sectional distortion. Distortions, although negligible with regard to stress computation because of the low magnitudes of stresses, may not be ignored in the examination of deflection and rotation. The specimens, however, were elastic since rotations returned to zero when applied loads were removed.

4.4 Stresses in Top Bracing

Measured and estimated normal stresses in some top bracing members were compared. Members examined include tension and compression diagonals in the simple span portions (Figs. 17 and 18) and diagonals in the overhanging parts (Fig. 19). No measurements were made of the stress magnitudes in the transverse bracing members. It has been shown experimentally⁽¹⁰⁾ that, with both diagonal and transverse bracing members, the stresses in the transverse bracing members are insignificant until the diagonal members have yielded or buckled. During the current tests, all bracing members were elastic and no buckling occurred. All bracing members of the specimens, however,

considered in the evaluation of the thickness of the equivalent top flange.

The measured and estimated stresses agreed well. The greater differences of stresses were found in members located in panels adjacent to the loading points. The maximum differences of stresses was 2 ksi, only slightly higher than that for points in the webs and the bottom flange. This result appears to be very good indeed, and the validity of the analytical model is strongly proved.

5. DISCUSSION AND RECOMMENDATIONS

Based on the comparison of analytical and experimental results, the following conclusions may be drawn.

1. The concept of equivalent closed box section provided a means of describing the behavior of braced open box sections. The stresses in the braced section could be evaluated fairly accurately, thus would ensure open box girders not being over-stressed during construction.

2. The rotation of the braced open box sections were underestimated, although the predicted and experimental rotations had the same order of magnitude and were much smaller than those for unbraced open sections.

3. The stresses in the diagonal bracing members could be adequately estimated through analyzing the bracing frame, which was subjected to forces from the equivalent closed box section.

It was pointed out earlier that the applied loads on the braced open box girders were 80 - 100 percent of the loads which would cause first yielding of the unbraced open sections. These load magnitudes were lower with respect to the yield loads of the braced open sections; being 40 - 50 percent for the two specimens. Experimental verifications are needed to ensure acceptable behavior of braced open sections under higher loads.

Buckling of the box girder components or the box girder as a whole must be considered so as to prevent drastic failure. For the specimen of this study, the web buckling loads were below the yield loads of the braced open box sections. Possible buckling of bracing members must also be investigated in the selection of bracing member geometry.

The selection of bracing members is through a trial procedure. From the results of this study, the following procedure is recommended.

1. Select a bracing arrangement (Fig. 5).
2. Assume an imaginary equivalent top flange, forming a closed box section. Because even a very thin top flange increases the torsional rigidity of the box section significantly (Fig. 20). The thickness, t_e , of the imaginary plate may only need to be very small.
3. Solve for area of bracing members by using our approximate form of Eq. 1 and the assumed t_e . Determine the dimensions of the bracing frame.
4. Compute stresses of the equivalent closed section by Eq. 3. Stresses in the actual components of the box section must be acceptable.
5. Determine, from the computed stresses in the equivalent top plate, the forces which act in the bracing frame.
6. Compute stresses in the bracing members. Check strength and stability of these members. If not within

acceptable limits, increase t_e and repeat the procedure.

In conclusion, it should be emphasized that, although the results of this analysis are very encouraging, additional confirmation must be carried out before any application can be made. Studies which should be made to confirm the present finding include further experimental work, more analysis on rotation, and effects of deformation of cross sections.

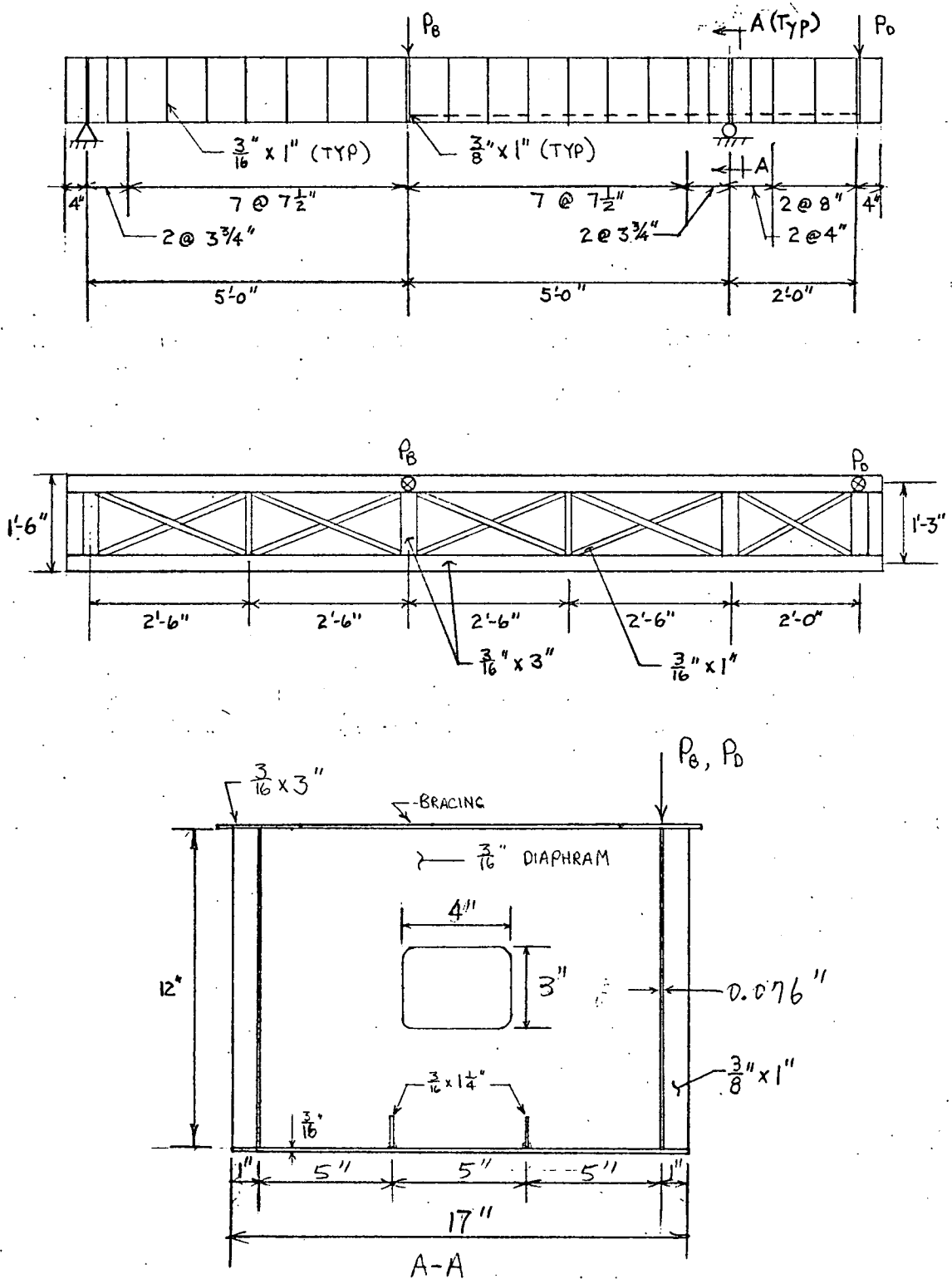

Fig. 1 GEOMETRY OF BRACED SPECIMEN - D1

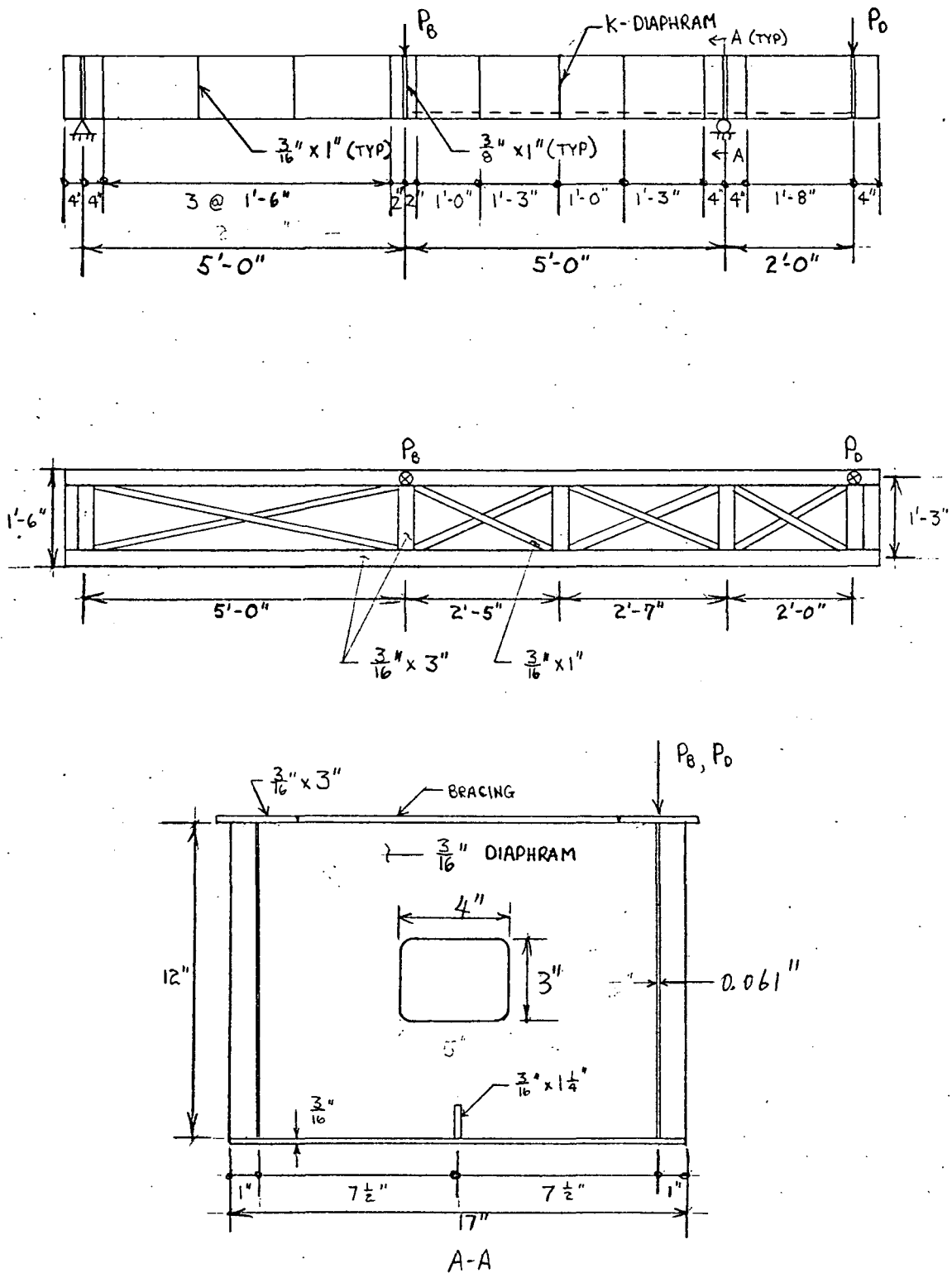

Fig. 2 GEOMETRY OF BRACED SPECIMEN - D2

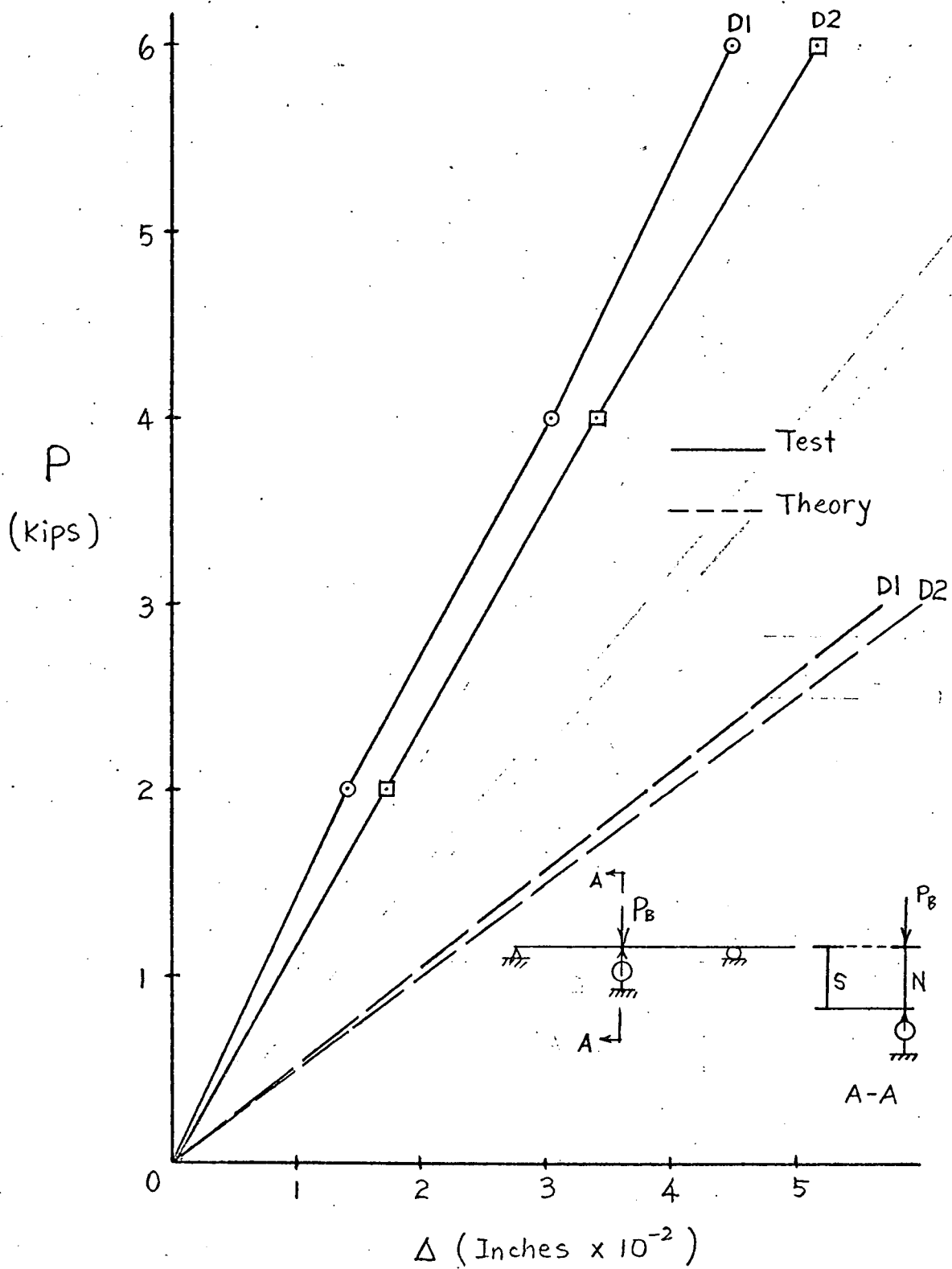

Fig. 3 MIDSPAN DEFLECTION UNDER LOAD

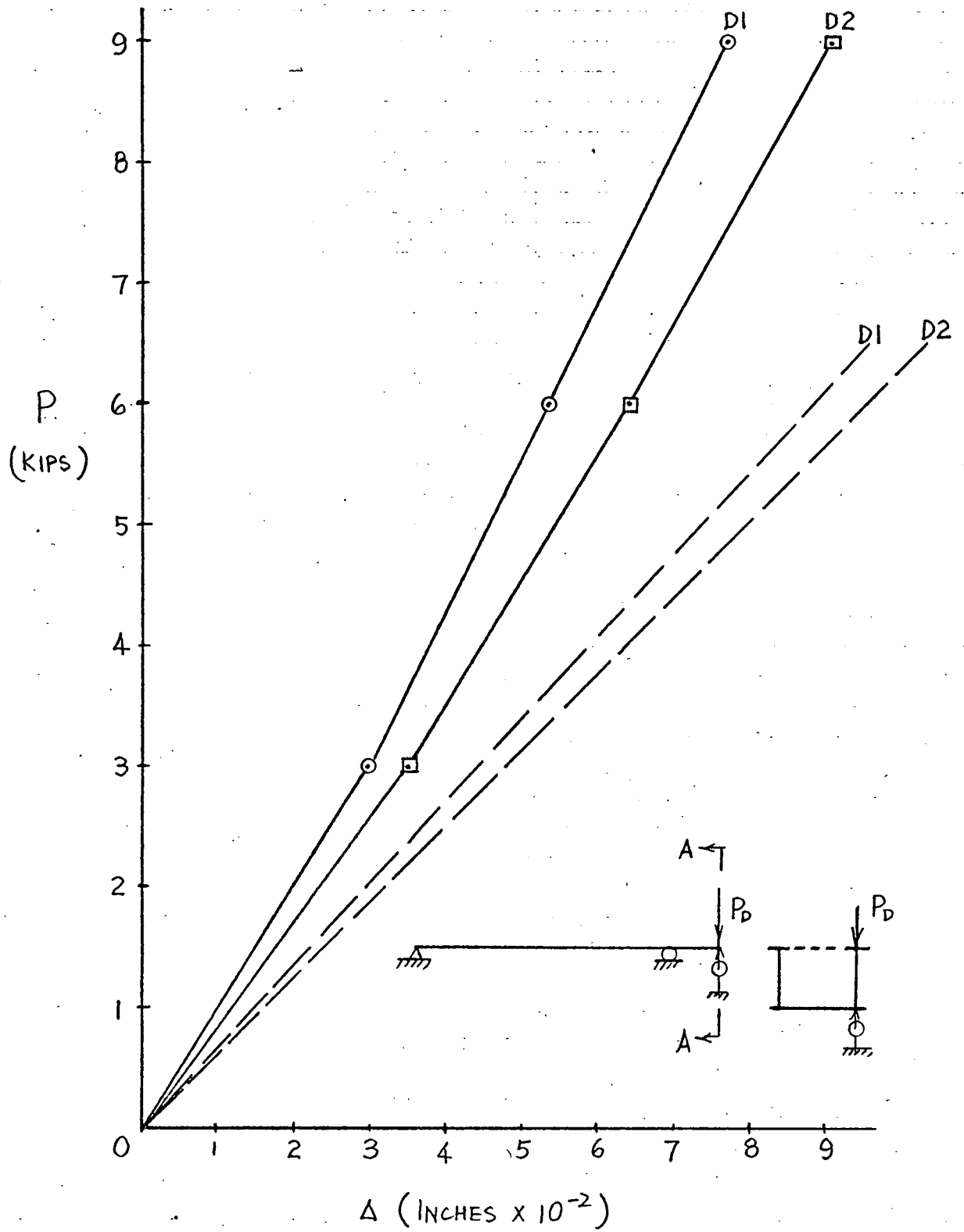
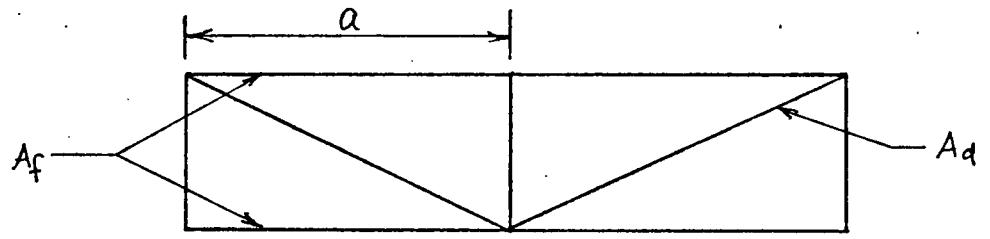
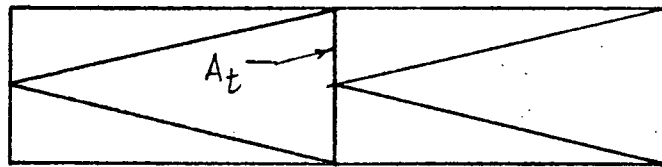

Fig. 4 DEFLECTION AT OVERHANG, UNDER LOAD



(a)



(b)

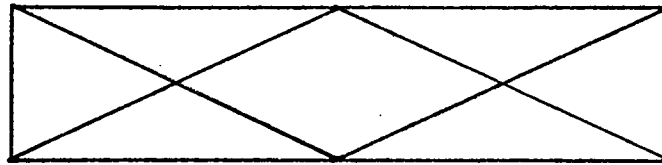

(c)

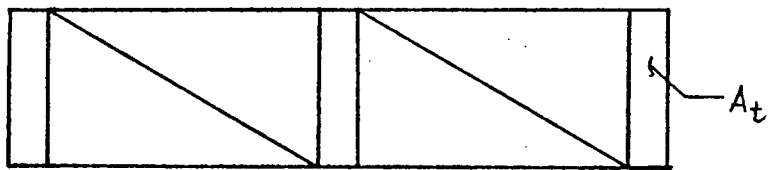

(d)

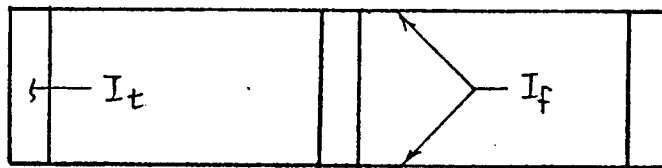

(e)

Fig. 5 TOP BRACING ARRANGEMENTS

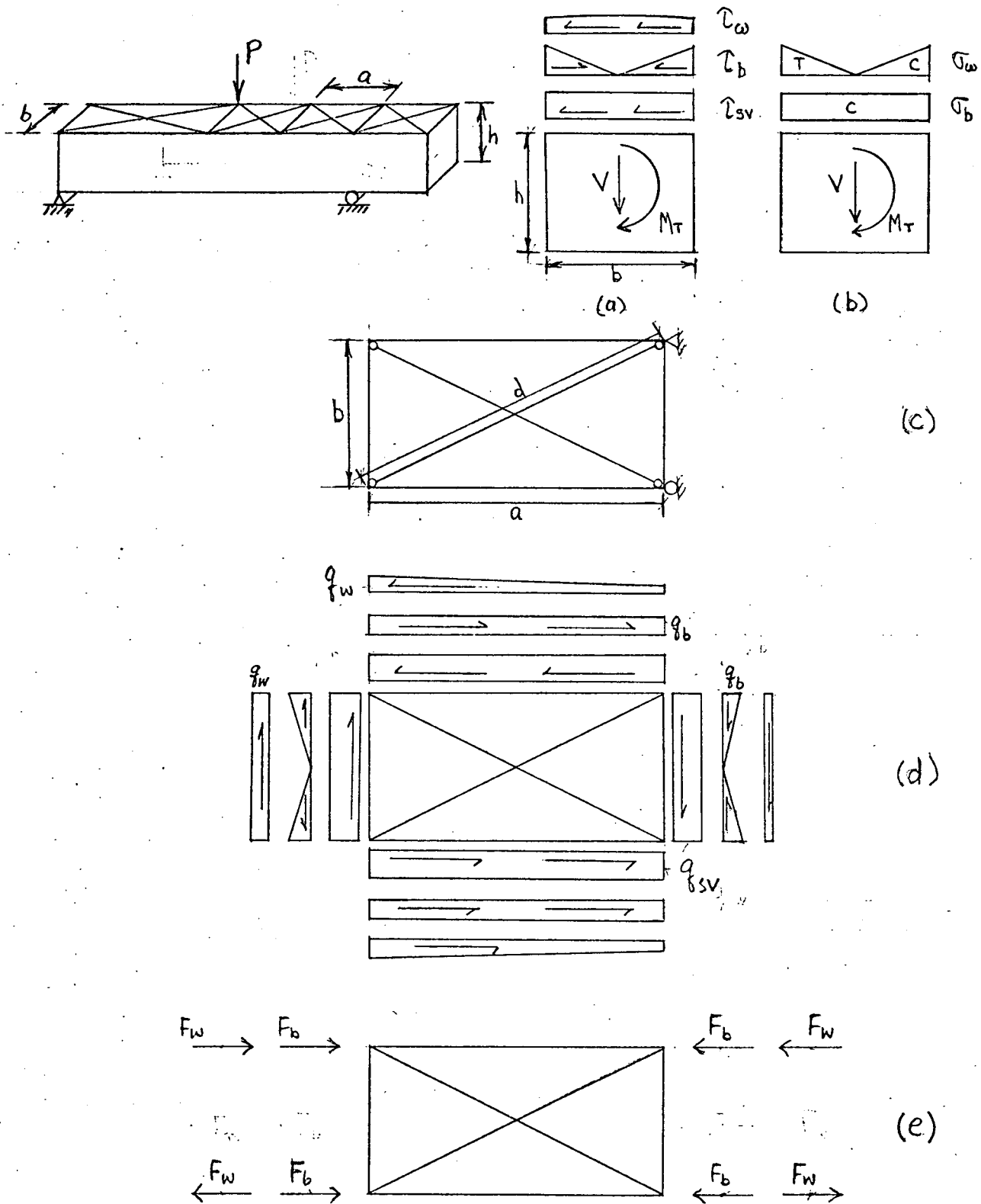

Fig. 6 STRESSES ON EQUIVALENT TOP PLATE AND LOADING CONDITIONS FOR TOP BRACING FRAME

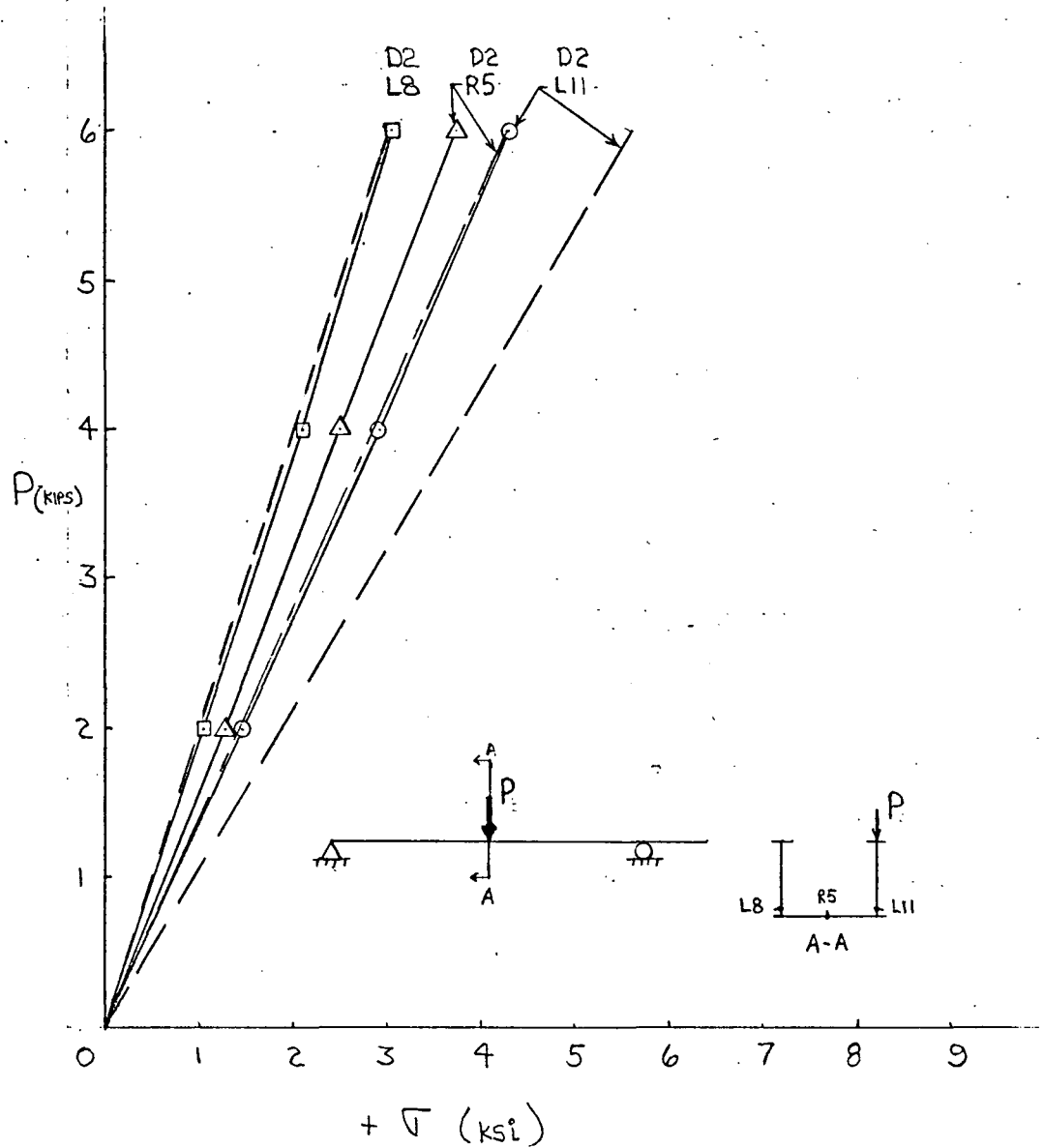

Fig. 7 NORMAL TENSILE STRESSES IN OPEN BOX SECTION - LOAD AT MIDSPAN

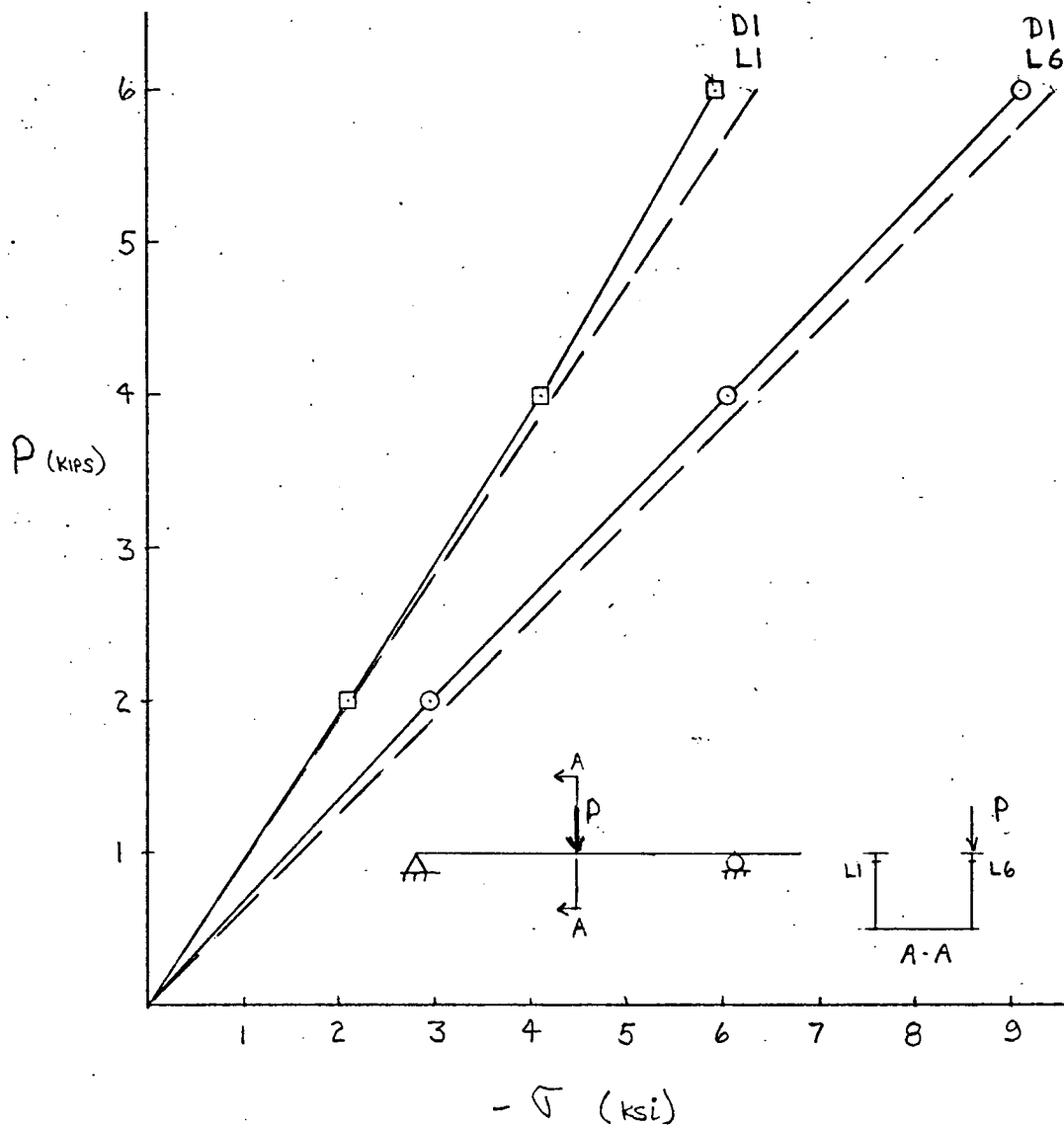

Fig. 8 NORMAL COMPRESSIVE STRESSES IN OPEN BOX SECTION - LOAD AT MIDSPAN

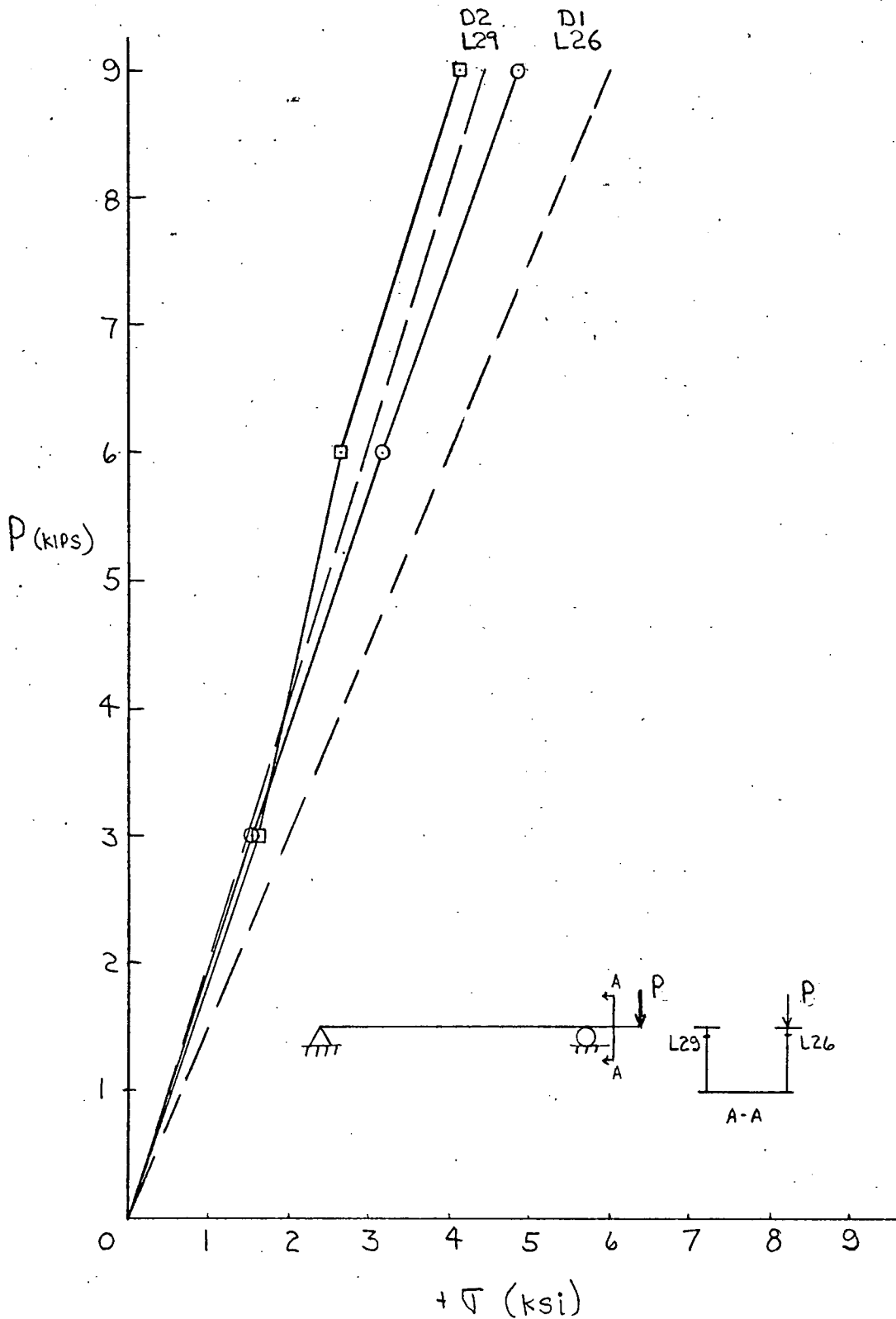

Fig. 9 NORMAL TENSILE STRESSES IN OPEN BOX SECTION - LOAD AT OVERHANG

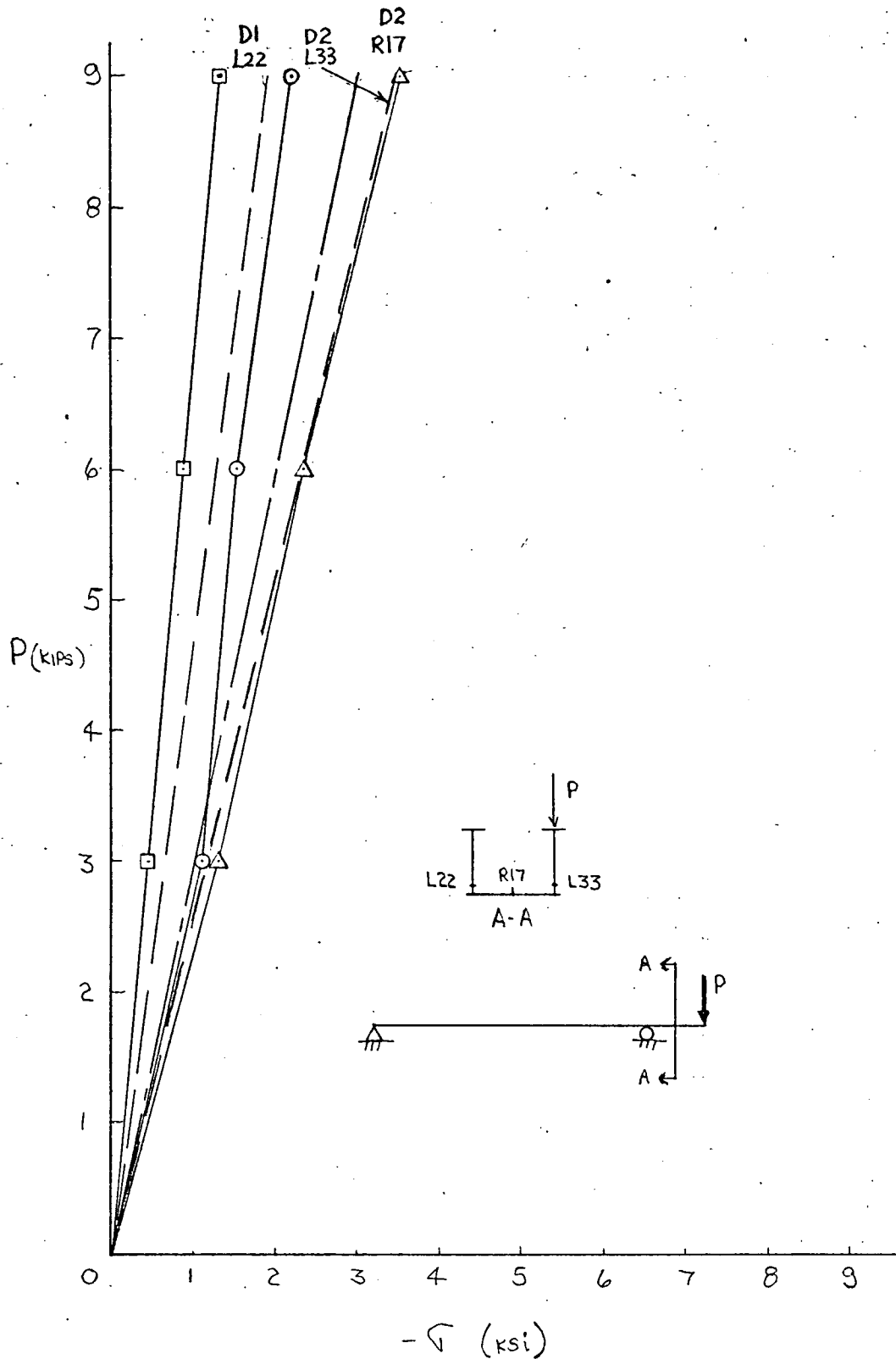

Fig. 10 NORMAL COMPRESSIVE STRESSES IN OPEN BOX SECTION - LOAD AT OVERHANG

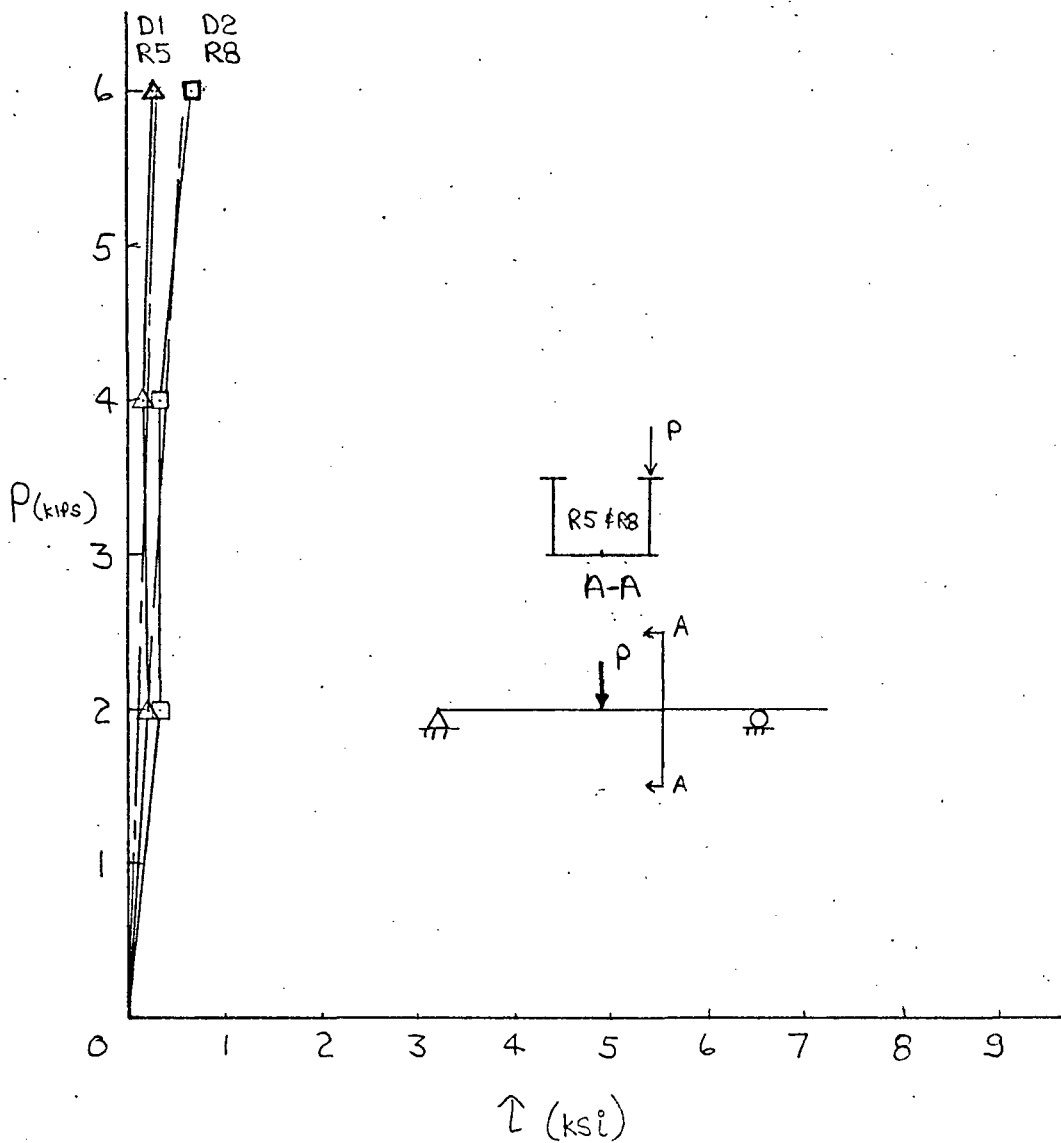

Fig. 11 SHEAR STRESSES AT CENTERLINE OF BOTTOM FLANGE - LOAD AT MIDSPAN

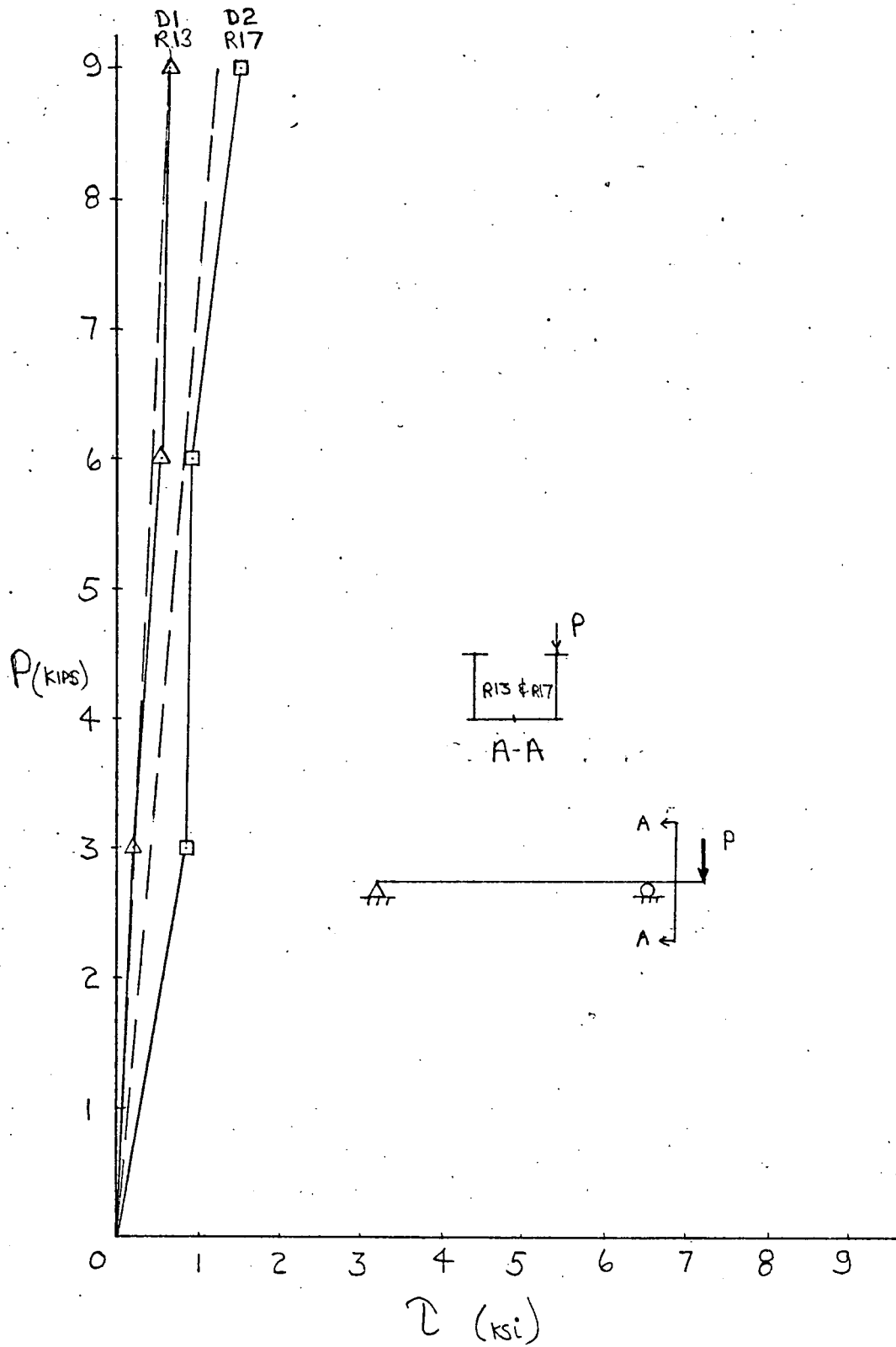

Fig. 12 SHEAR STRESSES AT CENTERLINE OF BOTTOM FLANGE - LOAD AT OVERHAND

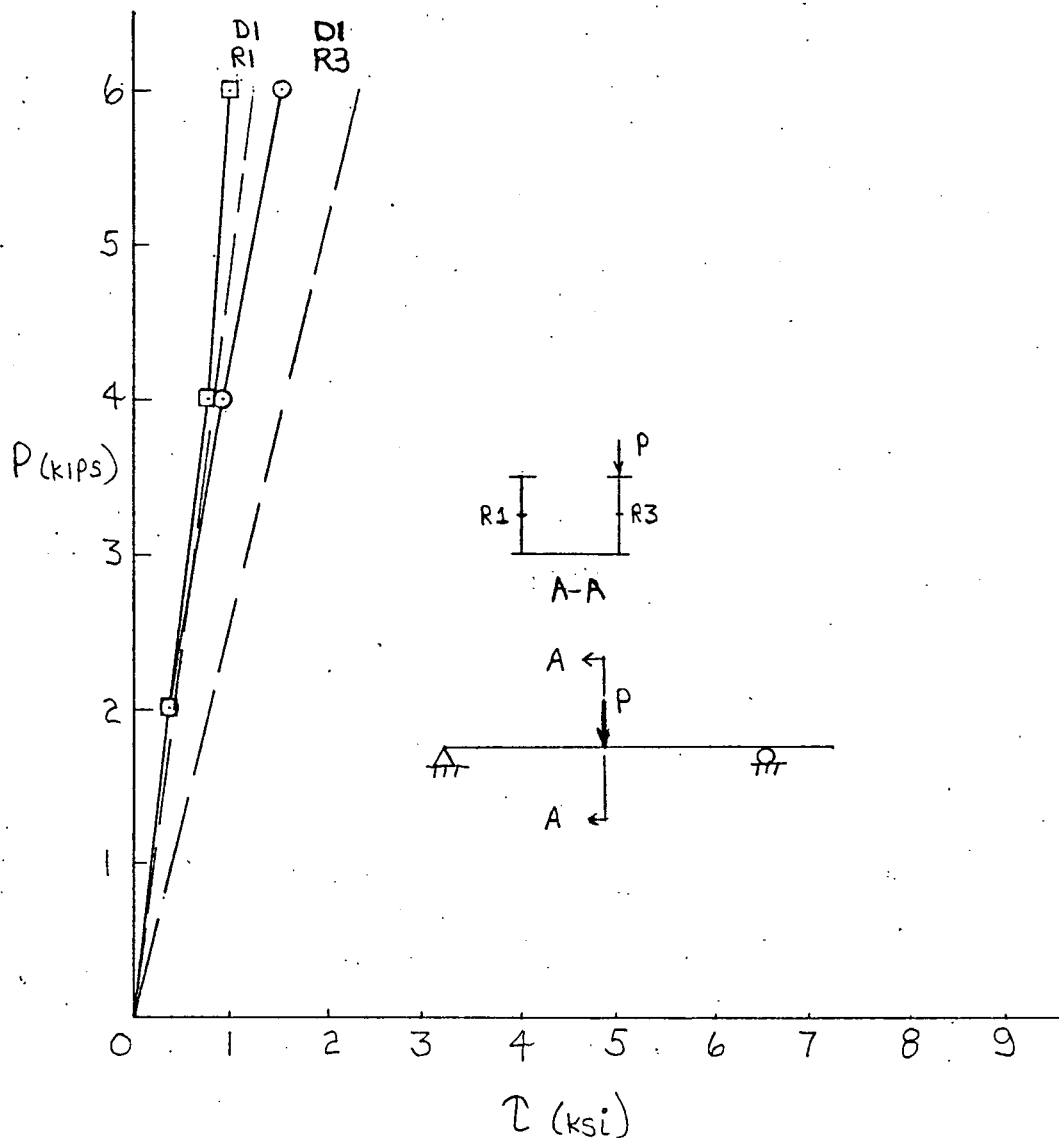

Fig. 13 WEB SHEAR STRESSES - LOAD AT MIDSPAN

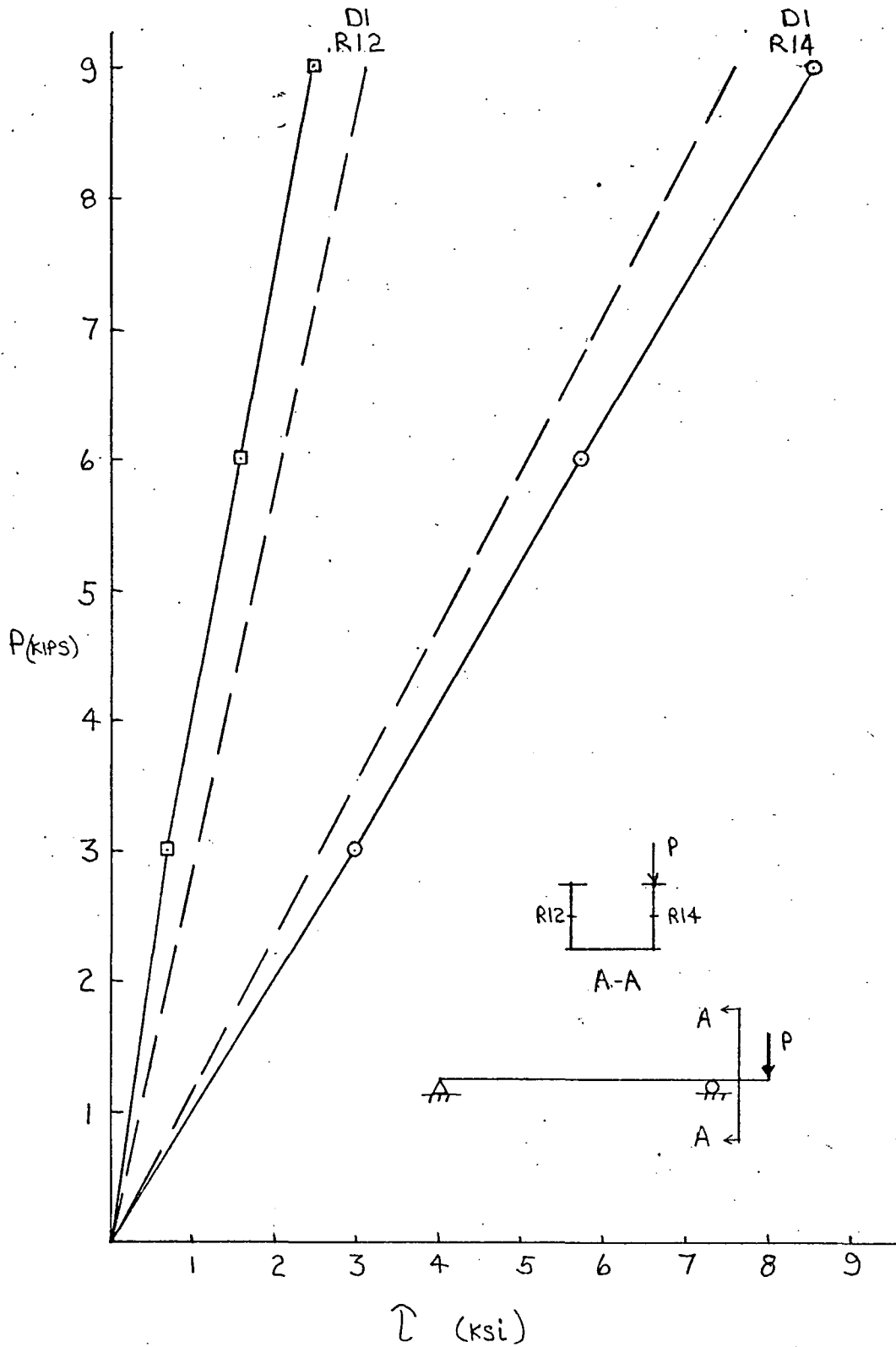

Fig. 14 WEB SHEAR STRESSES - LOAD AT OVERHAND

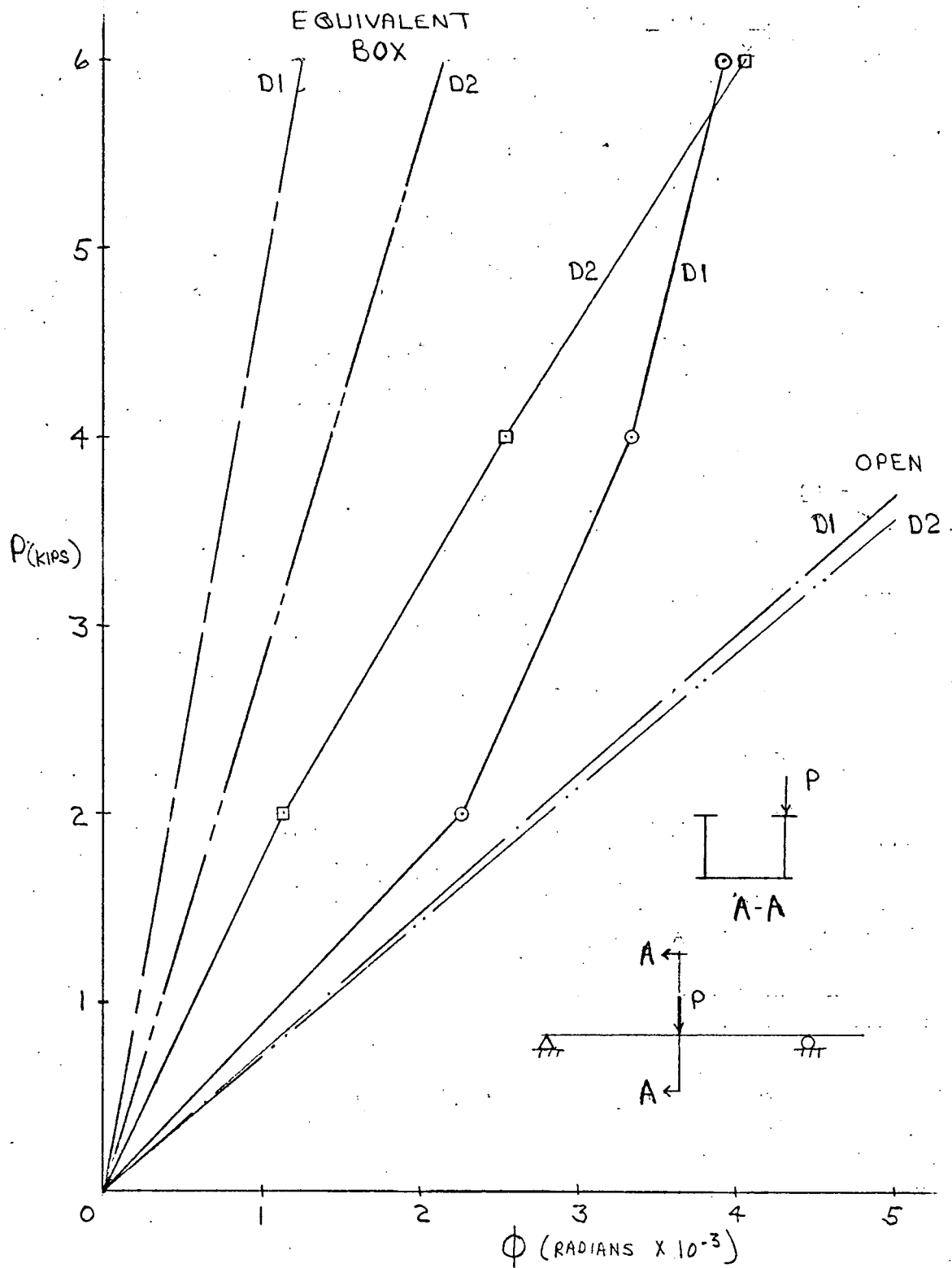

Fig. 15 MIDSPAN ROTATION

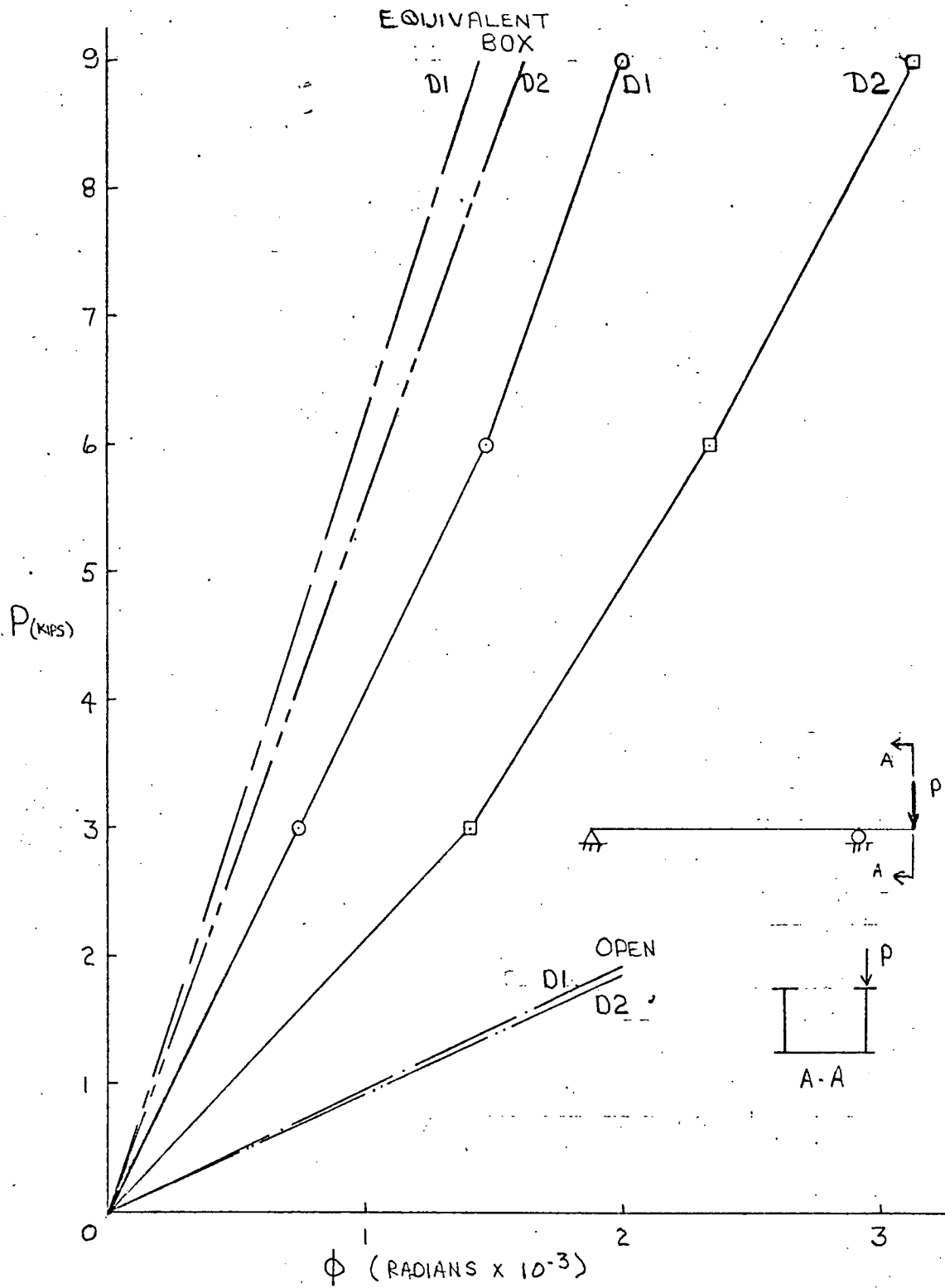

Fig. 16 ROTATION AT OVERHANG

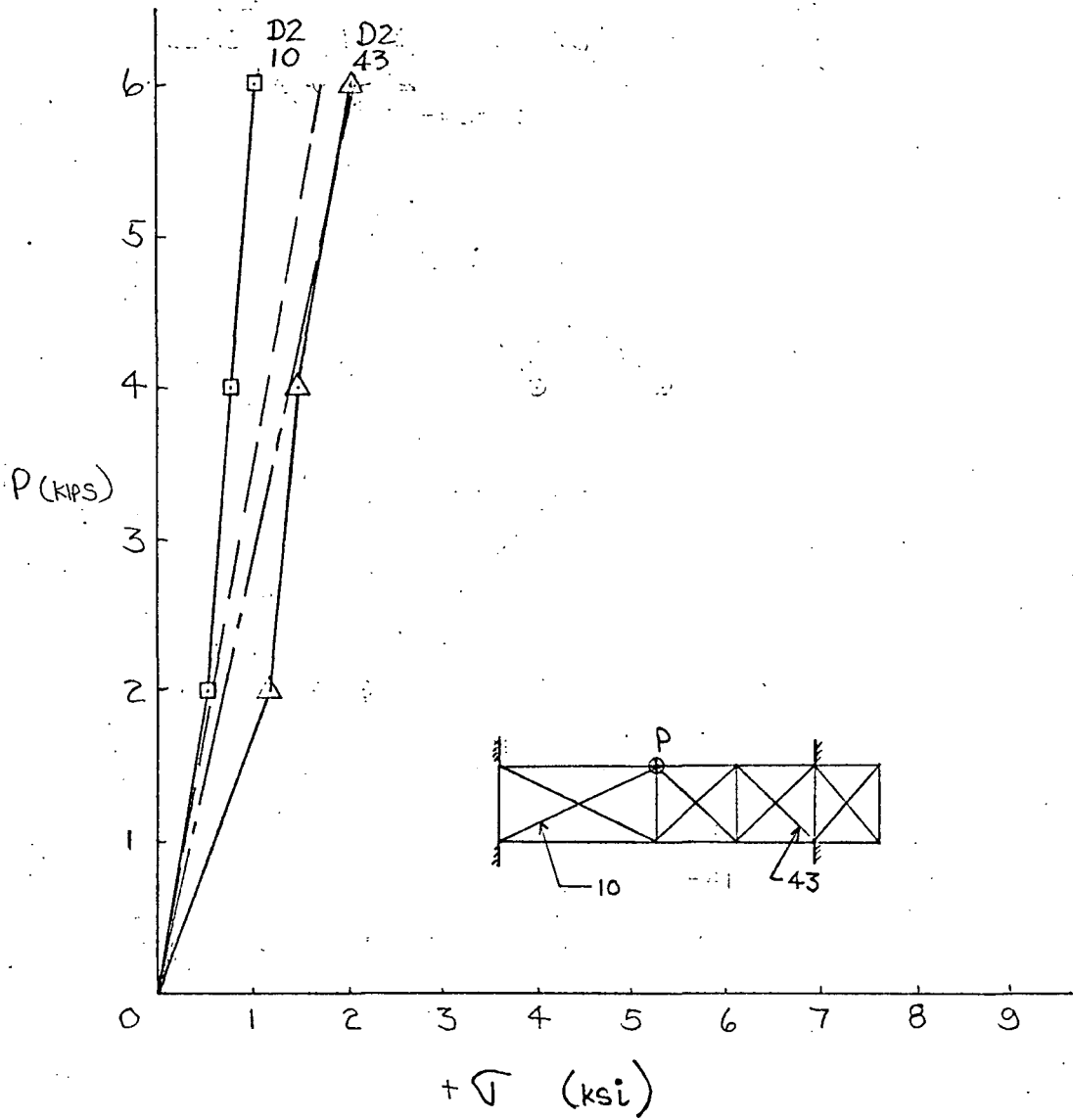

Fig. 17 TENSILE STRESSES IN TOP BRACING - LOAD AT MIDSPAN

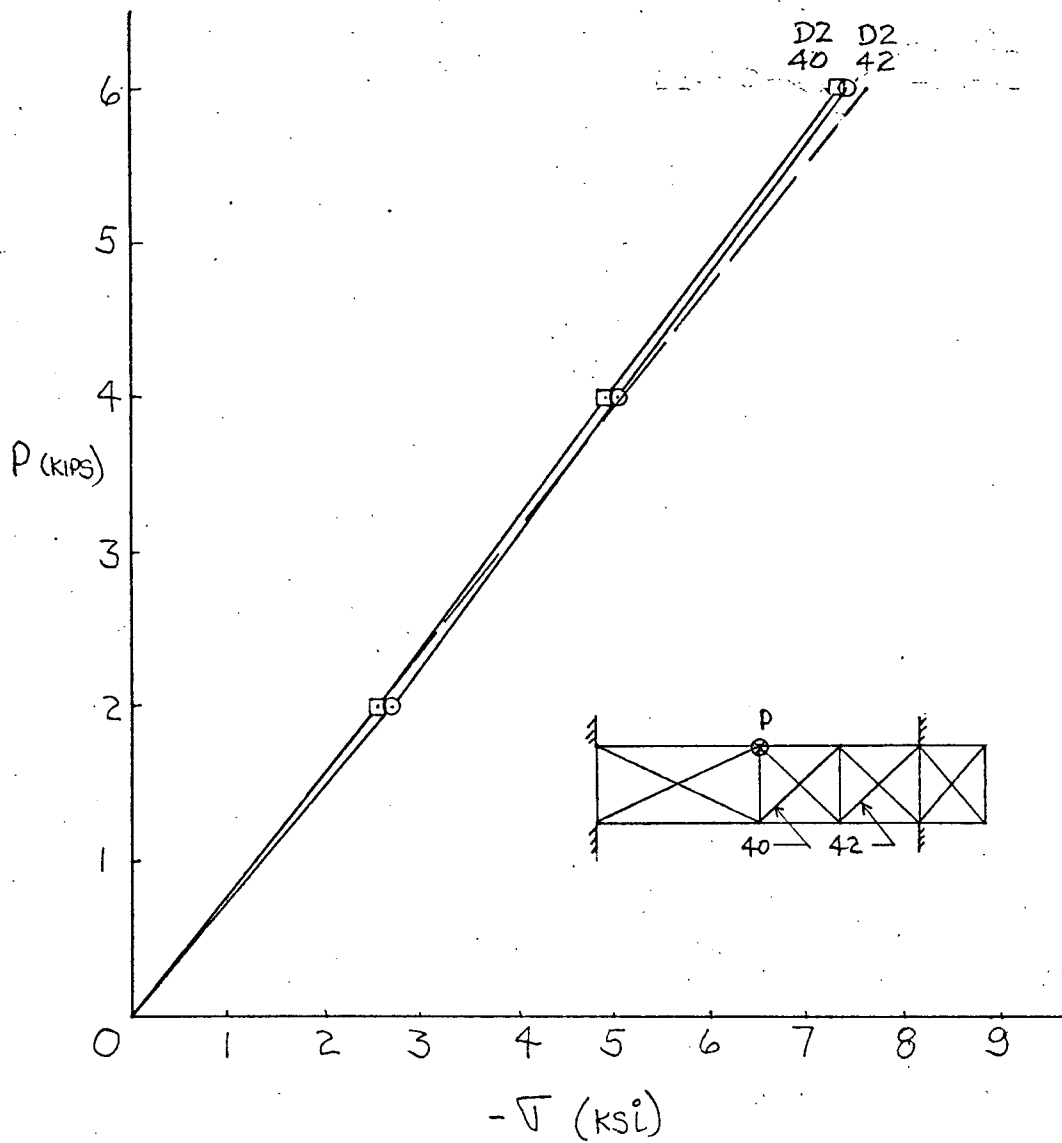

Fig. 18 COMPRESSIVE STRESSES IN TOP BRACING - LOAD AT MIDSPAN

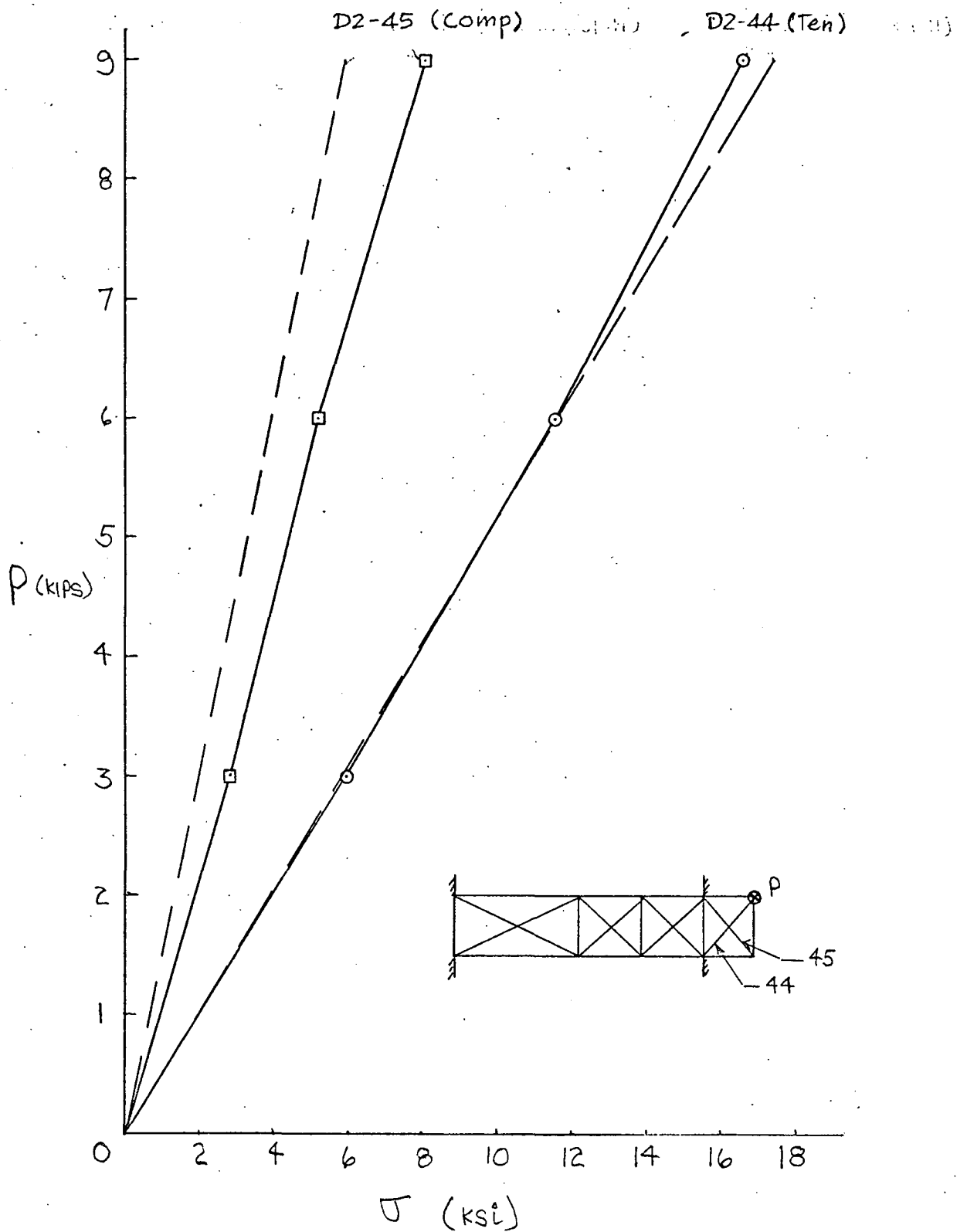

Fig. 19 NORMAL STRESSES IN TOP BRACING - LOAD AT OVERHANG

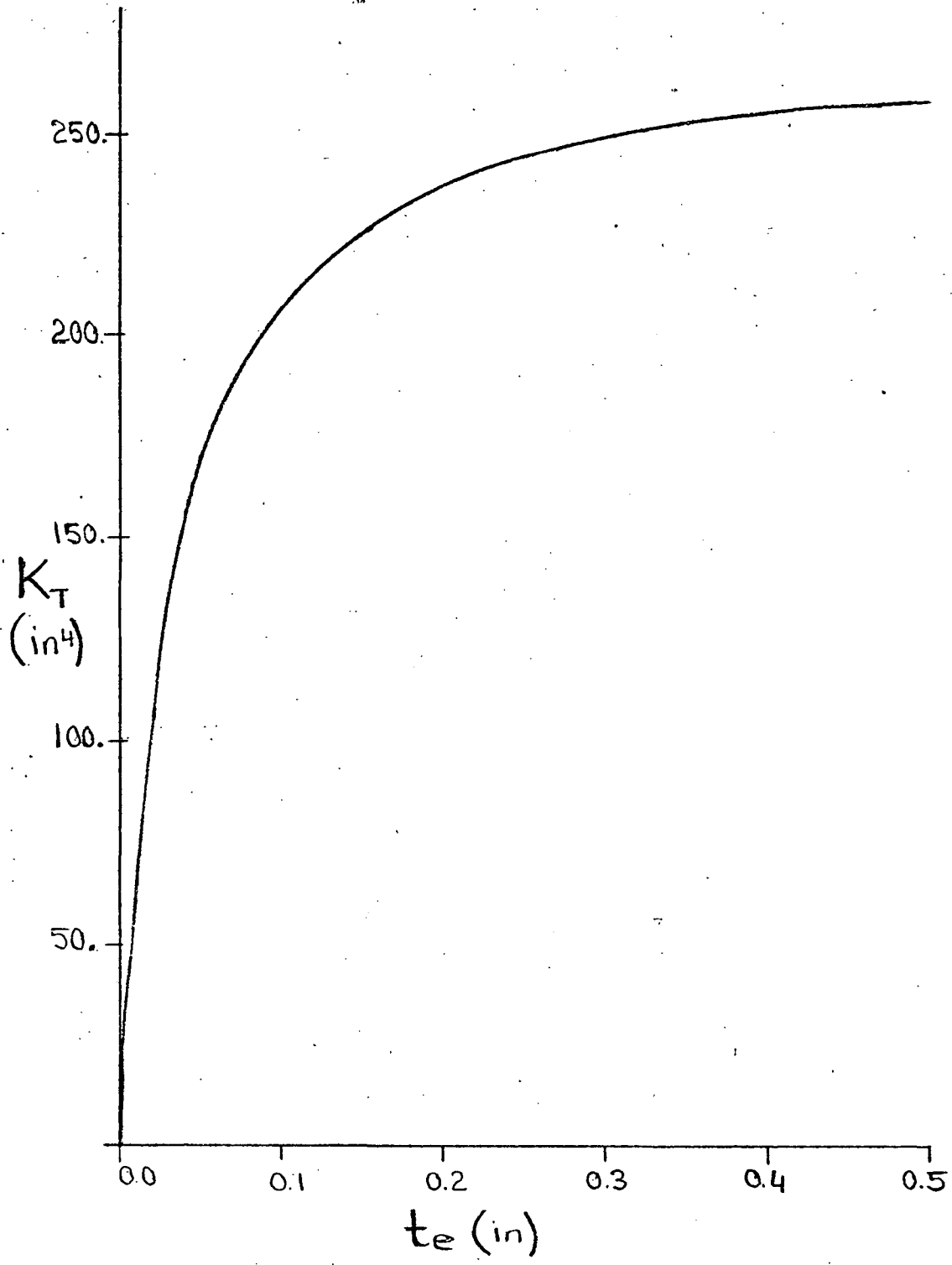

Fig. 20 K_T VERSUS T_e - SPECIMEN D1

REFERENCES

1. Yen, B. T., Chen, Y. S. Yilmaz, C., McDonald, R. E. and Ostapenko, A.,
TESTS ON MODEL COMPOSITE BOX GIRDERS, Fritz Engineering Laboratory
Report No. 380.6, Lehigh University (In preparation)
2. AASHO
STANDARD SPECIFICATIONS FOR HIGHWAY BRIDGES, 10th Edition, 1969
3. AASHO
INTERIM SPECIFICATIONS, 1971
4. Basler, K. and Kollbrunner, C. F.,
TORSION IN STRUCTURES, Springer-Verlag, 1969
5. Sines, George
ELASTICITY AND STRENGTH, Allyn and Bacon, Inc., 1969
6. Wright, R. N., Abdel-Samad, S. R. and Robinson, R. R.,
REF ANALOGY FOR ANALYSIS OF BOX GIRDERS, Journal of the
Structural Division, ASCE, Vol. 94., No. ST 7, July 1968
7. Goldberg, J. R. and Leve, H. L.
THEORY OF PRISMATIC FOLDED PLATE STRUCTURES, Publications,
IABSE, Vol. 17, 1957
8. Vlasov, V. Z.
THIN-WALLED ELASTIC BEAMS, Office of Technical Services,
U. S. Department of Commerce,
9. Galambos, Theodore V.
STRUCTURAL MEMBERS AND FRAMES, Prentice Hall, Inc. 1968
10. Rao, N. R. N.
TORSIONAL BEHAVIOR OF THIN-WALLED OPEN SECTIONS REINFORCED
BY BRACING, Fritz Engineering Laboratory Report No. 354.275,
Lehigh University, March 1964

VITA

The author was born March 23, 1949 in Laramie, Wyoming. He is the first son of Robert E. and Betty A. McDonald.

In June 1967, he graduated from Machebeuf High School in Denver, Colorado. He attended Lafayette College in Easton, Pennsylvania from September 1967 to June 1968 and the University of Wyoming from September 1968 to June 1971 when he received his Bachelor of Science degree in Civil Engineering. He is a member of Sigma Tau, engineering honorary fraternity and an associate member in American Society of Civil Engineering.

In September 1971, he enrolled in the Graduate School of Lehigh University and held the position of Teaching Assistant for one year. Starting in June 1972, he became a Research Assistant for the project "Strength of Rectangular Composite Box Girders", while working for his Master of Science degree in Civil Engineering.

He is married to the former Cynthia A. Mullinnix of Casper, Wyoming.