

1951

# Lateral and local buckling of i-beams in plastic range

C. H. Yang

Follow this and additional works at: <http://preserve.lehigh.edu/engr-civil-environmental-fritz-lab-reports>

---

## Recommended Citation

Yang, C. H., "Lateral and local buckling of i-beams in plastic range" (1951). *Fritz Laboratory Reports*. Paper 1377.  
<http://preserve.lehigh.edu/engr-civil-environmental-fritz-lab-reports/1377>

This Technical Report is brought to you for free and open access by the Civil and Environmental Engineering at Lehigh Preserve. It has been accepted for inclusion in Fritz Laboratory Reports by an authorized administrator of Lehigh Preserve. For more information, please contact [preserve@lehigh.edu](mailto:preserve@lehigh.edu).

205B.7

LATERAL AND LOCAL BUCKLING OF I BEAMS IN PLASTIC RANGE

(A part from the Ph.D. dissertation of Ching Huan Yang)

(5) LATERAL AND LOCAL BUCKLING OF I BEAMS IN PLASTIC RANGE

Shanley, in his paper on inelastic column theory,<sup>(10)</sup> has proved that an ideal column will start to bend at a load equal to its tangent modulus load. According to the average stress and strain diagram of structural steel, the slope of the curve in the plastic range before strain hardening is zero. That leaves the criterion of the tangent modulus load without real meaning in the limiting case.

In columns loaded with a slight eccentricity (provided the columns are made of a material which exhibits the above-stated zero slope through the plastic range), the average compression stress on the column cross section can never reach the yield point.

Ideally loaded columns made of perfectly plastic material are actually unstable when the average stress reaches yield point. It may collapse at any instant when the average stress reaches the yield point regardless what length the column has.

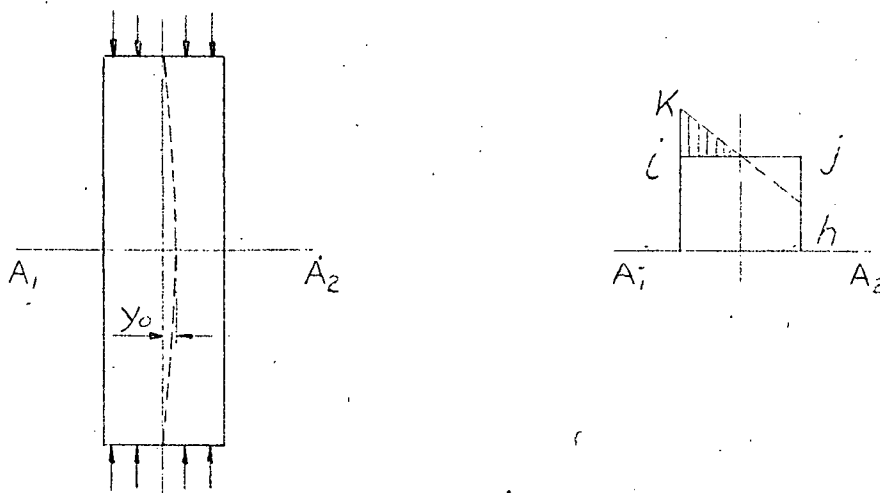

FIG. IV. 30

This statement can be demonstrated as follows:

Let  $P_0$  be the load at which the average compression stress on the column reaches the yield point

$$P_0 = a \sigma_y,$$

where "a" equals the total cross section area of the column.

Suppose the ideal column is loaded with axial load  $P_0$ , and we make a virtual displacement along the column as the dotted lines show above. Take a cross section A,A. Let the corresponding displacement at that section be  $Y_0$ . Then the section will be under total axial load  $P_0$  and a moment  $M = P_0 Y_0$ . In order to balance both the moment and the axial load, the stress distribution must be changed from  $jk$  to  $hi$ . But the stress cannot be any higher than  $\sigma_y$  if the material is perfectly plastic. The stress distributed in the shaded area in the above Fig. is therefore impossible. The external moment will not be balanced. It is obvious that the column will collapse in bending at once.

This would lead to a conclusion that a member should never carry compressive stress to the yield point if it is made of materials that have perfect plasticity after yielding.

In simple plastic theory, sections in structural members at which stresses exceed the yield point are assumed

to develop "plastic hinges". In the case of "I" sections there is, from the above discussion, a possibility of buckling of the compression flange in the region of the so-called "plastic hinge". The buckling of the compression flange would naturally reduce the value of plastic hinge moment. Therefore the problem of instability of structural steel members becomes very important in the simple plastic theory of structural design.

Stress and strain curves for ordinary tension or compression tests do not give enough information for the analysis of stability problems in the plastic range. None of the metals used in engineering structures are perfectly plastic and an ordinary stress and strain diagram usually gives no information of the relation between stress and strain rate in plastic range. The mechanism of yielding of the metal also affects the buckling strength of the compression member.

Take the previous column; the moment at section  $A_1 A_2$  may be very small at the beginning. If this moment makes the column bend, then the strain rate at side  $A_1$  will naturally be higher than at side  $A_2$ . The stress at side  $A_1$  will be raised by the higher strain rate that makes the stress distribution over the cross section possible to balance the external moment, and the column will then bend and shorten at the same time until the strain hardening range is reached.

In a simple tension or compression test of a structural steel one will find that Luder's lines do not all appear at once when the yield point is reached. Yield lines usually are initiated in some places and then gradually spread over the whole specimen. While the yield lines are progressing, the region where the yield lines were initiated might have developed all its plastic strain and reached the strain hardening range locally. The specimen can not be considered as perfectly plastic even though the portion of the stress and strain diagram is observed to be parallel to the abscissa. The compression member can therefore be expected to have a buckling strength of the tangent modulus load in the plastic range where the tangent of the stress and strain curve is chosen at the starting point of the strain hardening range.

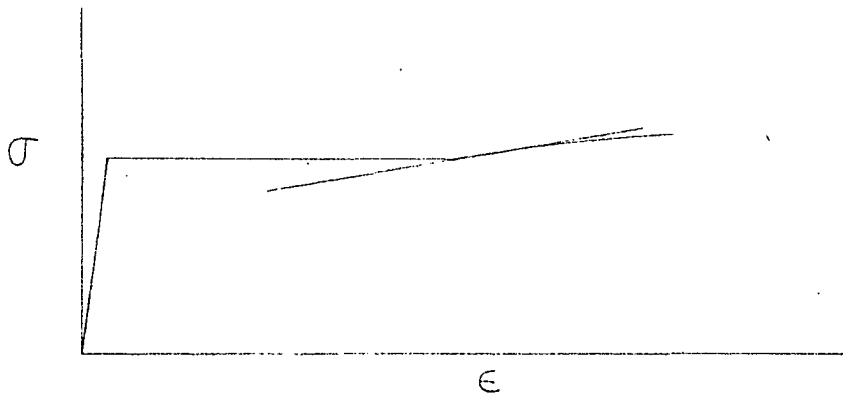

FIG. IV. 31

How does this yielding process affect the buckling strength of a compression member? It can be demonstrated by the following analogical example:

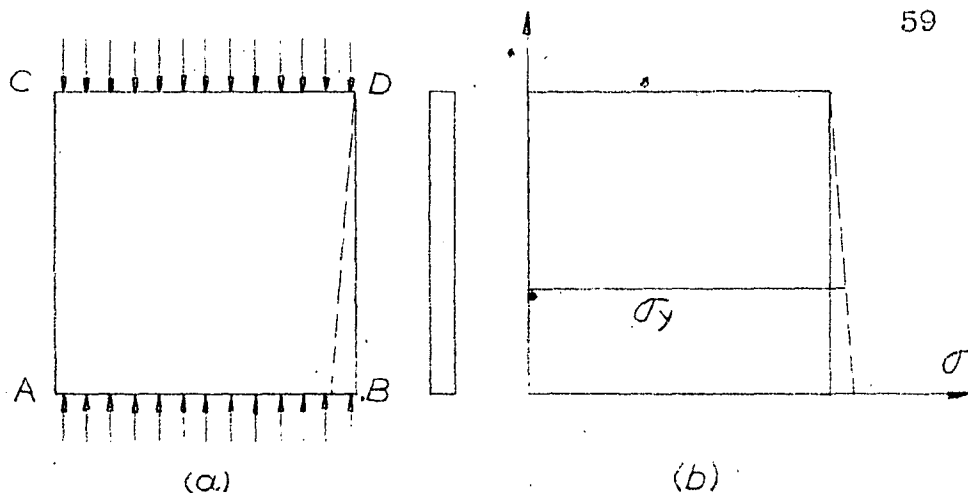

FIG. IV.32

Suppose the compression member is slightly tapered on one side, as shown in dotted lines in above Fig. IV.32(a). Instead of having a uniform cross section throughout the length, the stress distribution along the member will be as shown in dotted lines Fig. IV.32(b). The root section AB will reach the yield point first, and as stress increases the yielding zones will progress to reach the top section CD. If the mechanical properties of the material are homogeneous every section will be strain hardened as soon as the stress exceeds  $\sigma_y$ . During this progression of yielding the strain hardening zone and elastic zone are separated by only an infinitesimally thin plane which has perfect plasticity. In this case the compression member will, however, have a buckling strength at least equal to the tangent modulus load. The tangent of the stress and strain diagram is selected at the point of the starting of the strain hardening region as before.

To summarize the above discussion there may be two extreme cases:

First, if the material is perfectly plastic and stressed to the yield point, the compression member will be unstable and will bend no matter what the  $L/r$  ratio of the compression member is. Secondly, if the plastic flow in a compression member is established plane by plane and all the planes get strain hardened as plastic flow progresses the compression member will then have a buckling strength of tangent modulus load as defined above.

The practical case may lie between the above two extremes. Apparently the tangent modulus load defined as above will become the upper limit of the buckling strength for the compression member. For rectangular sections the tangent modulus load can be calculated as follows:

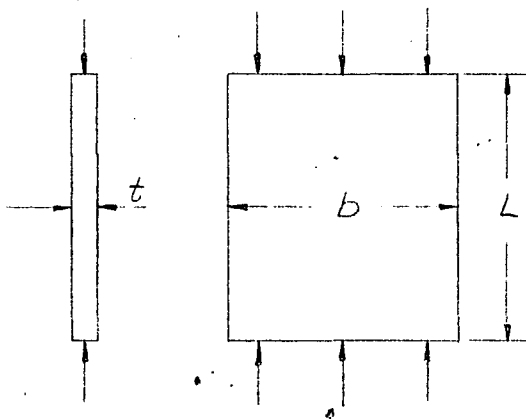

FIG. IV. 33



$$\frac{d\sigma}{d\epsilon} = E_t^* = 0.636 \times 10^3$$

$$I = \frac{bt^3}{12}$$

$$\sigma_y = 37.5 \quad \text{kips/inch}^2$$

$$P = a \sigma_y = bt \sigma_y$$

$$P = \frac{E_t I \pi^2}{L^2}$$

$$\frac{L}{t} = 3.75$$

$$\frac{L}{t} = 7.5 \quad \text{for the case of fixed end.}$$

Compression coupons were tested at a ratio of  $\frac{L}{t} = 4$ . Test conditions are simulated to the fixed end. No bending in the plastic range is observed. Stress and strain diagram showed a yield point in Fig. 35. More tests of very carefully aligned short compression members of various  $\frac{L}{t}$  ratios are needed to evaluate an effective value of the tangent modulus at the starting point of the strain hardening region to predict the buckling strength of steel structural members.

The lateral buckling problem of flexural members also becomes very serious in the plastic range. Take a simply supported I-beam under constant moment and suppose that both of the flanges are in the plastic range under constant moment.

---

\*  $E_t$  is the tangent at the starting point of the strain hardening portion of the stress-strain curve.

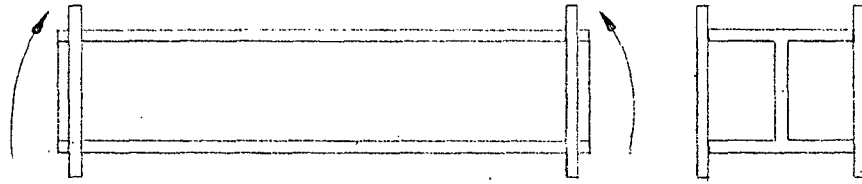

FIG. IV.34

According to the first assumption that the yielded part of the beam is perfectly plastic, it is obvious that the lateral buckling strength of the beam will be equivalent to a beam considering only the elastic part of the same beam under the same moment. According to the assumption that the yielded part of the beam will have a tangent modulus strength, the lateral buckling strength of this beam can be computed by regarding the beam as having different moduli in the elastic part and plastic part. The actual lateral buckling strength of such a beam is expected between the above two values.

The central portion of the tested continuous beams between the two loading points were all under constant moment. It is natural that when both flanges of this portion enter the plastic range, the lateral buckling strength of the beam will be greatly reduced.

Level bars were mounted perpendicular to the beam axis to measure the rotation of the beam. Curves are shown in Fig. 36. For 8WF40 section it is seen that lateral deformation

started between  $W = 45$  kips to  $W = 50$  kips. It was at this region, as observed from both the white wash and strain gages, that, the flanges went to the plastic range. Fig. 37 is a picture of beam B7 taken after the test, which shows that the central span buckled laterally in two half wave lengths.

Dial gages also were mounted near the supports between the tension and compression flanges to measure the local buckling in Beam B4 and B5 as shown in Fig. 38. Beam B7 has thinner flange thickness than all the rest of the beams. The compression flange buckled very severely as shown in Fig. 39.

#### (6) SHEAR FAILURE IN RECTANGULAR BEAMS OR IN WEBS OF I-

##### SECTIONS DUE TO TRANSVERSE LOAD

In the elastic beam theory, when a bending member is under transverse load, maximum shear stress is developed at the neutral axis. This shear stress is distributed as a parabolic function across the section according to the theory. As the beam is loaded to the plastic range this prediction of shear stress by the elastic theory is of course no longer valid. This shear stress, when its value becomes comparatively high, may initiate yielding in the web of the beam earlier than that of the normal stress in the outer fibre of the flange. The problem is discussed in the following three different cases:

## Table of Contents

	<u>Page</u>
(I) Synopsis	1
(II) Introduction	1
(III) Description of Experimental Program	
(1) Test set-up	3
(2) Preparation of specimen	5
(3) Strain gages, deflection gages and level bars	7
(4) Test procedure	10
(IV) Presentation and Analysis of Test Results	12
(1) Bending strength of I-sections under pure moment	12
a) M- $\phi$ relation of bending members	12
b) Strain distribution in plastic bending	17
(2) Initial yield strength of the continuous beams	18
a) Residual stress	18
b) Stress concentration	24
(3) Ultimate strength of continuous beams	31
a) Strain hardening effect of structural steel and the ultimate strength of continuous beams	32
b) The influence of end restraint on the ultimate strength of continuous beams	38
(4) Deflection of beams in plastic range	41
a) Method of simple plastic theory	42
b) Method of numerical integration	46

c)	Method of mathematical integration for I-sections	48
d)	Simplified method of mathematical integration for I-sections	50
(5)	Lateral and local buckling of I-beams in plastic range	55
(6)	Shear failure in rectangular beams or in webs of I-sections due to trans- verse load	63
(V)	Conclusions	73
(VI)	References	74
(VII)	Appendixes	
A.	Coupon test results	77
B.	Residual stresses	82
C.	Determination of initial yield strength in experimental load-deflection curves	85
(VIII)	Nomenclature	87

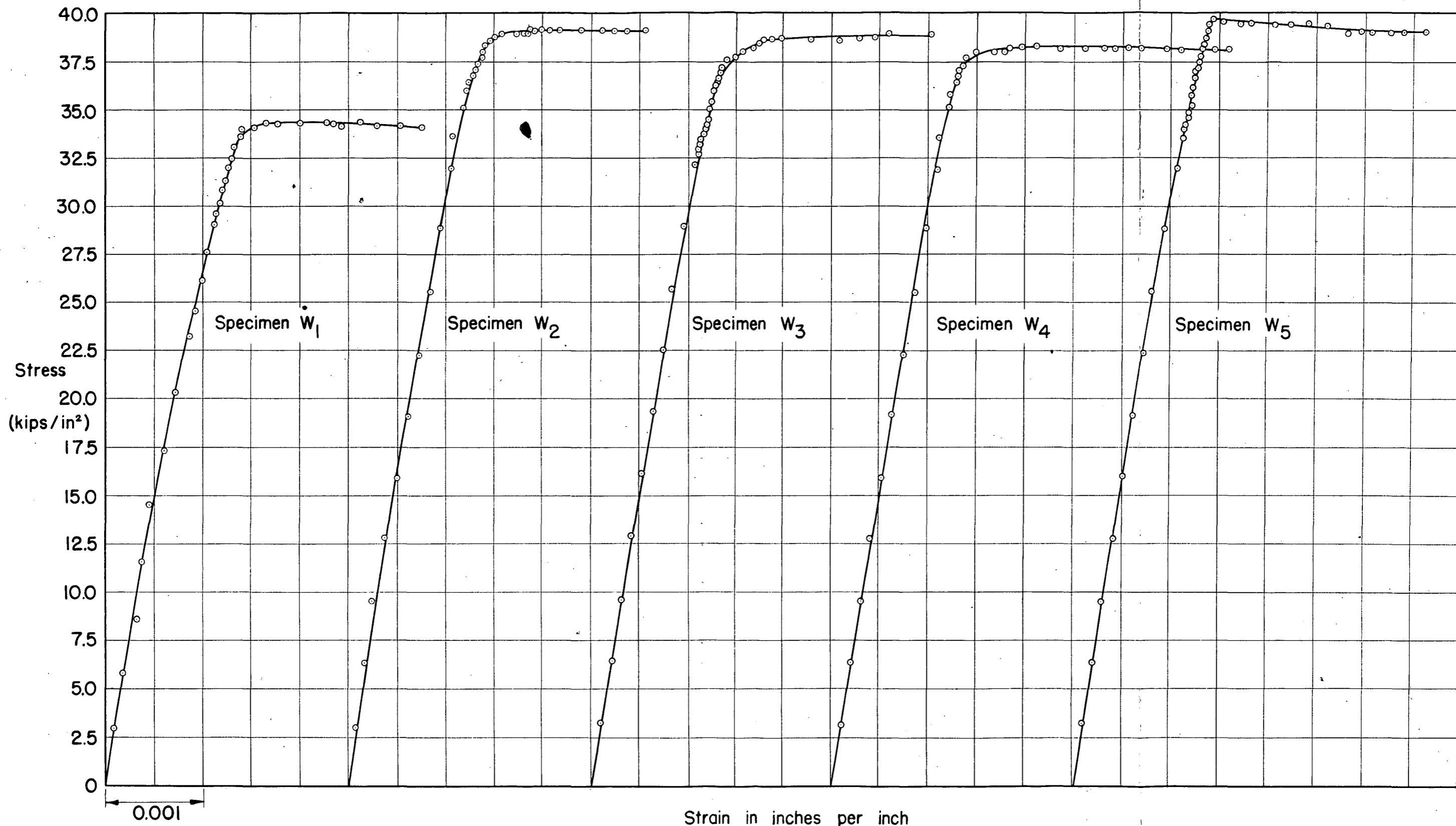

COMPRESSION STRESS-STRAIN CURVE FOR AN 8WF40 BEAM

Fig. 35

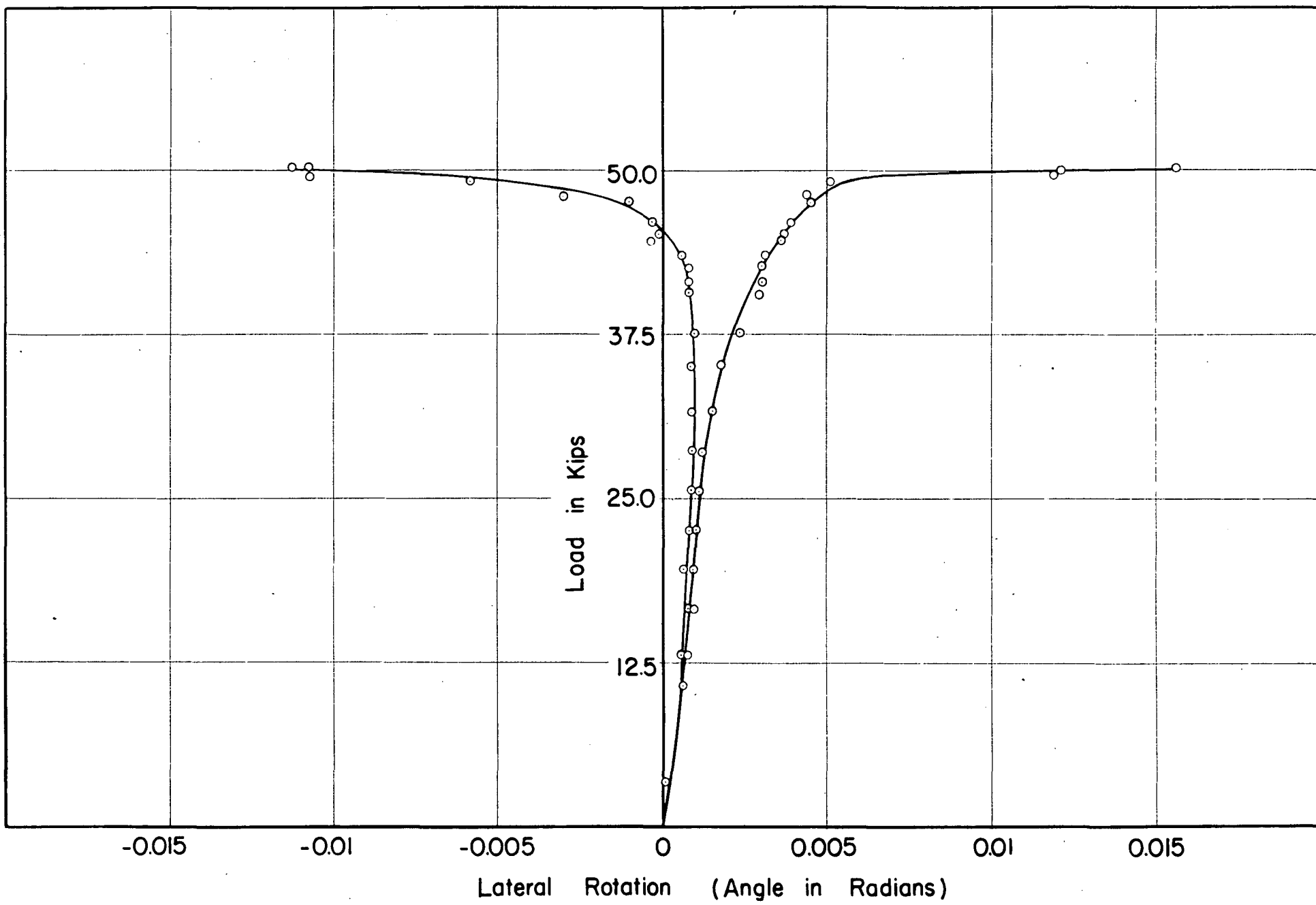

Beam 3

Fig 36a

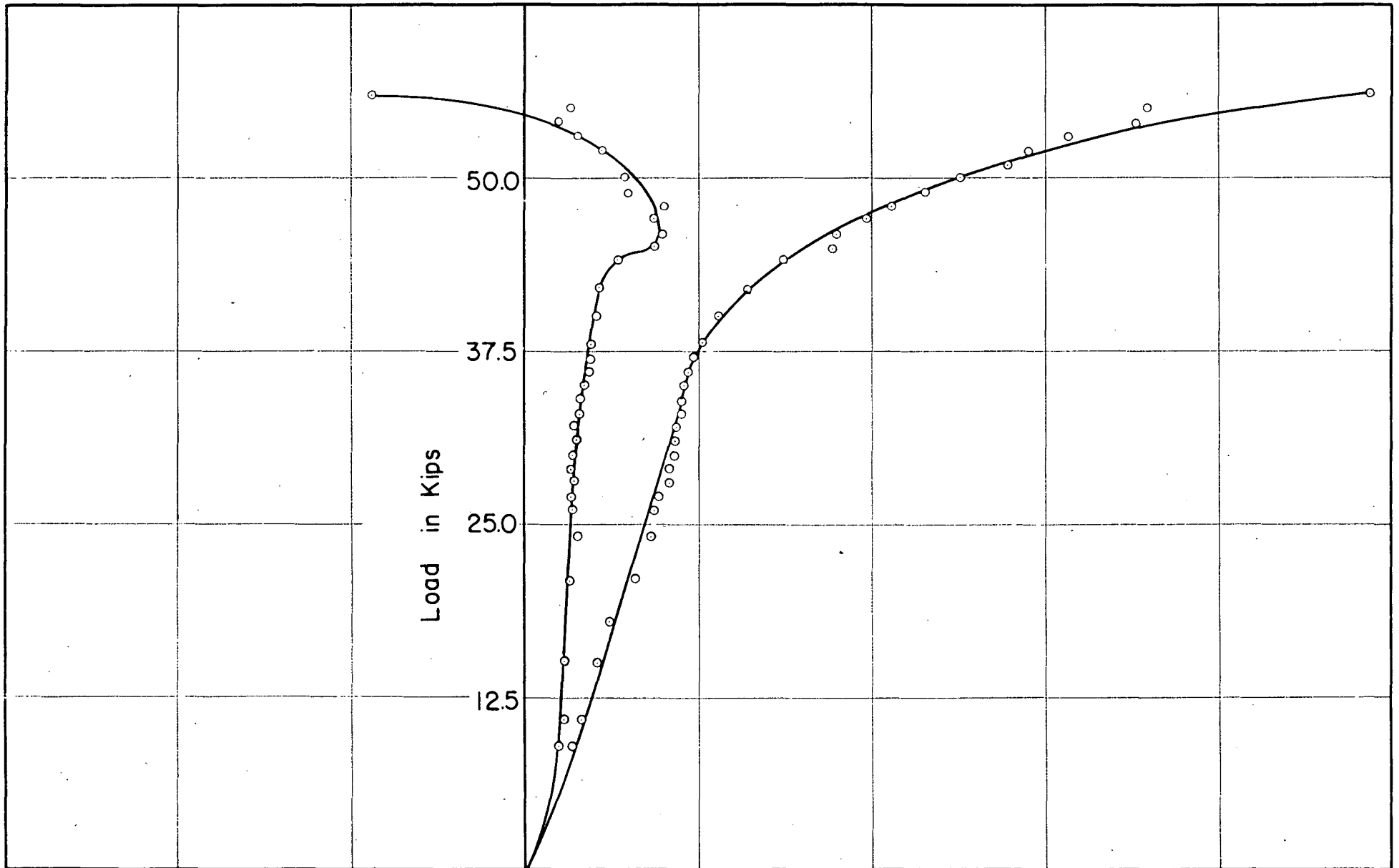

Beam 4

Fig 36b



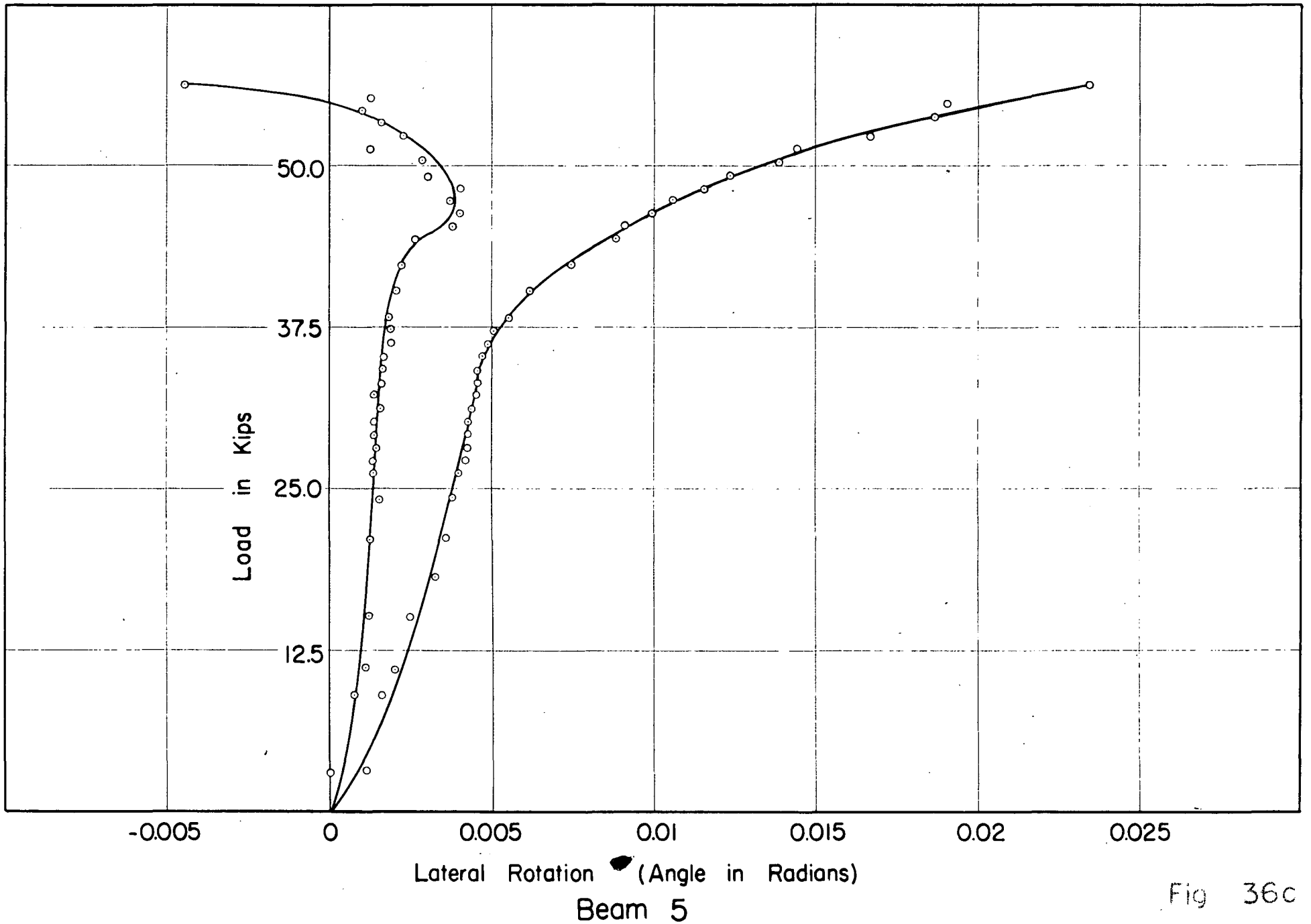
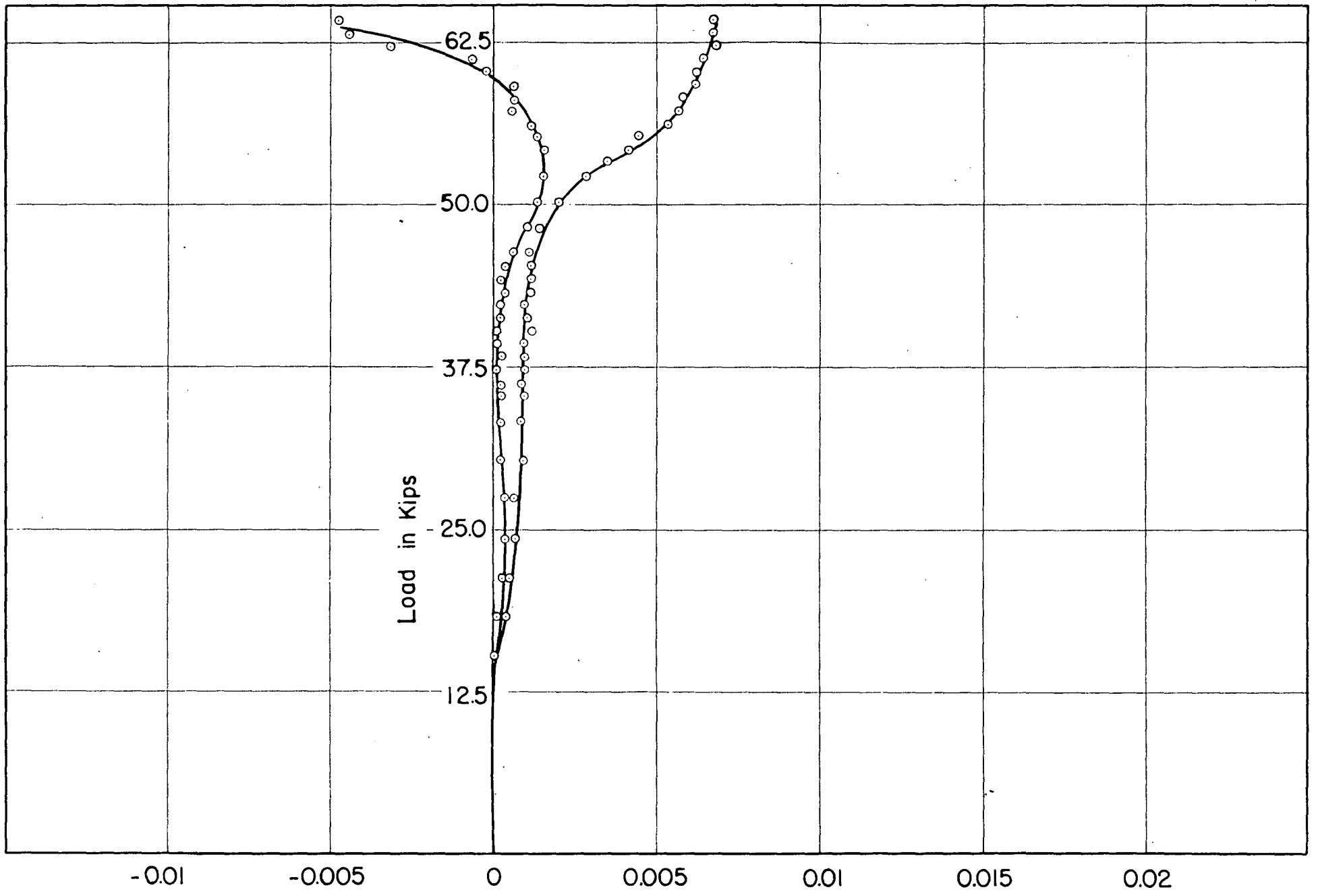

Fig 36c



Lateral Rotation (Angle in Radians)  
Beam 7

Fig 36d

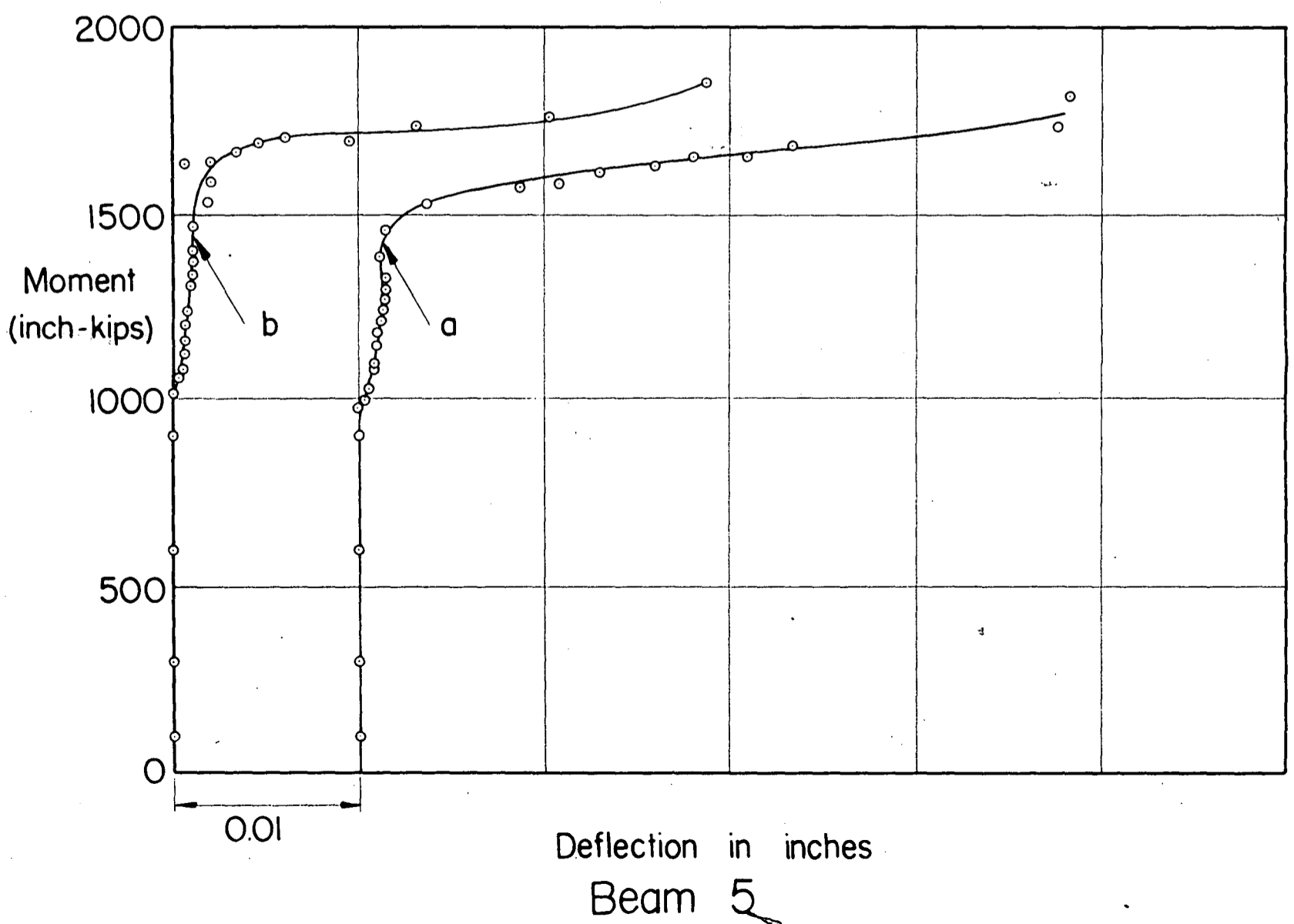
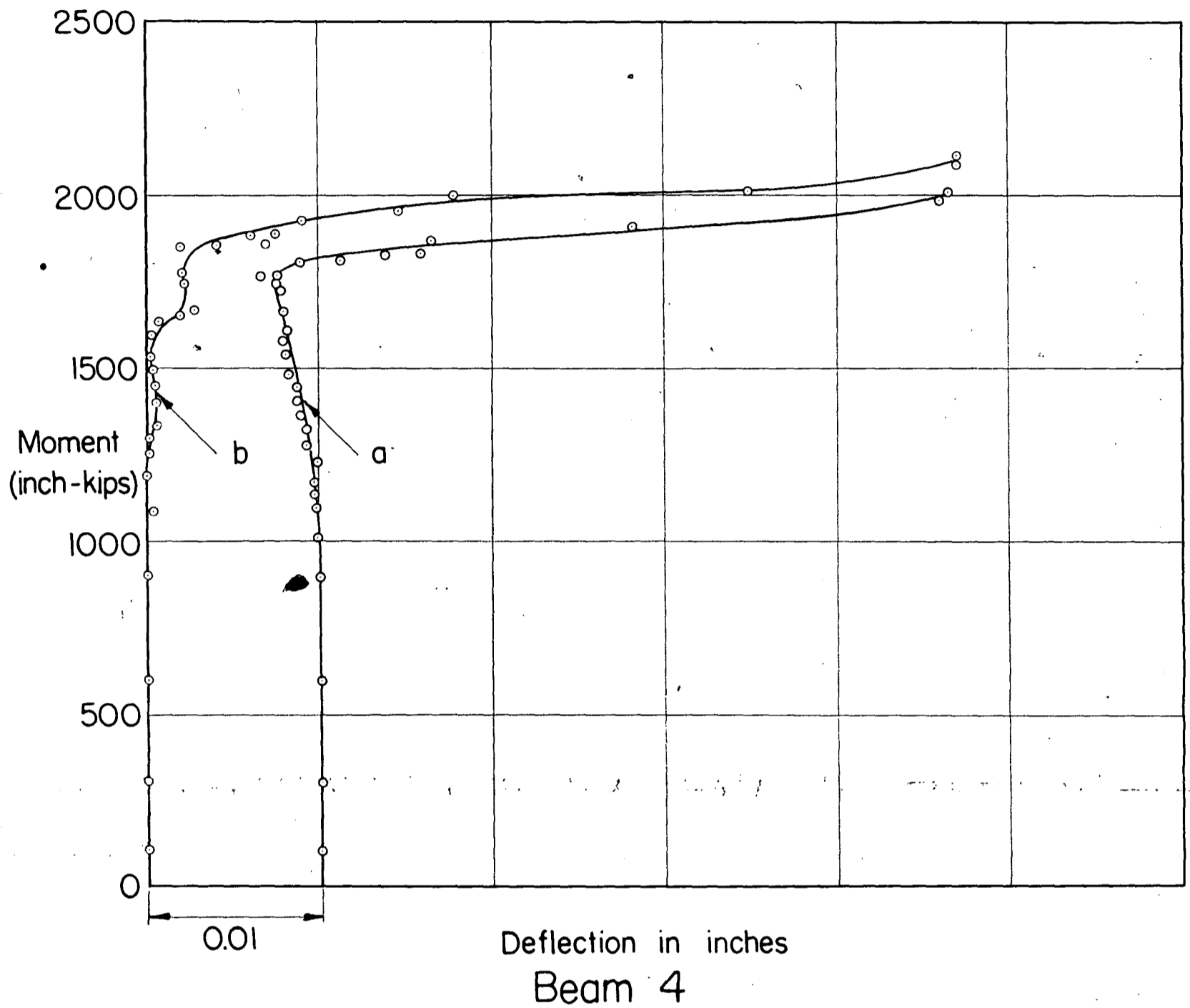
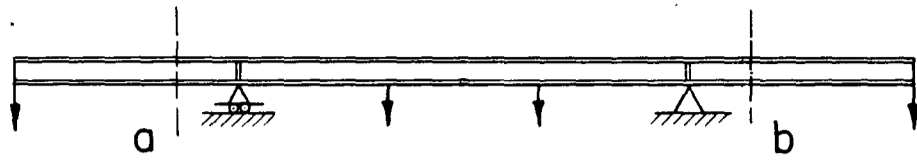

Fig 38

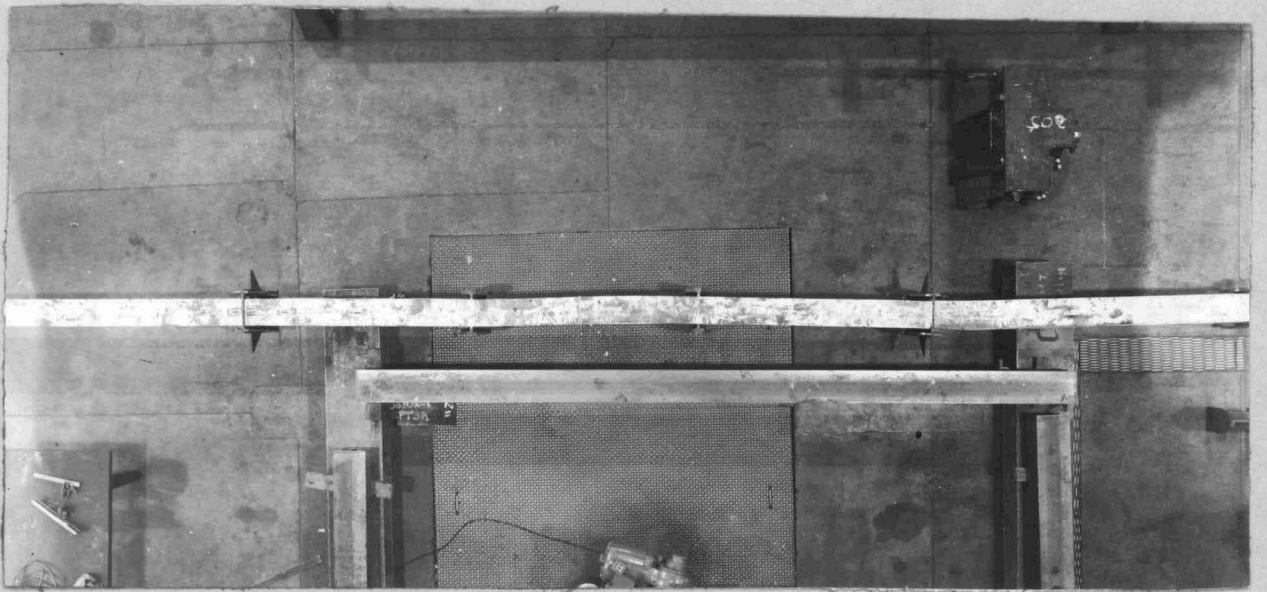

Fig. 37

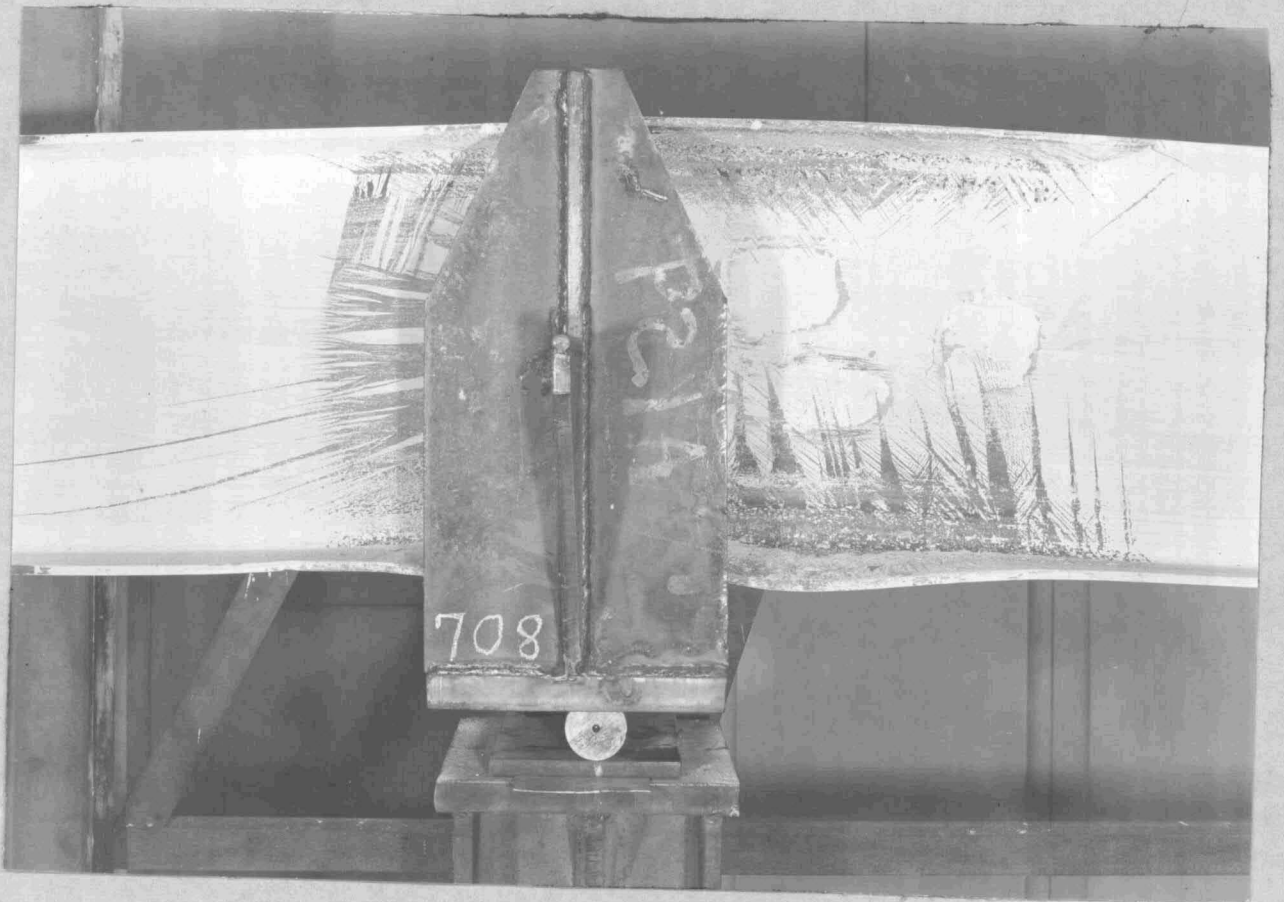

Fig. 39